

SONNETZ-MARKE



MARQUE DÉPOSÉE

AKTIEN-GESELLSCHAFT

V. GLUTZ-BLOTZHEIM NACHFOLGER

SOLOTHURN

SWITZER

STABLISSEMENT FONDÉ EN 1860

Album Nr. 3

Drücker, Oliven, Schilder, Knöpfe, Handhaben, Nägel

1860

Poignées, Ecussons, Boulons, Clous

SOCIÉTÉ ANONYME

V. GLUTZ-BLOTZHEIM SUCCESSEURS

SOLEURE

SWISSE

STABLISSEMENT FONDÉ EN 1860



1904

Gravé par les Ateliers d'Art de Solothurn

Dieses digitalisierte Dokument ist ein Nachschlagewerk aus der Geschichte der Firma Glutz. Eine Nachproduktion der gezeigten Beschläge wird auf Anfrage geprüft. Für die Herstellung kommen die gleichen Fertigungsverfahren zum Einsatz wie bei der damaligen Produktion.

Ce document numérisé est un ouvrage de référence de l'histoire de la société Glutz. Une reproduction des ferrures présentées est à l'étude sur demande. Les procédés de fabrication utilisés pour la production sont les mêmes que ceux utilisés à l'époque.

**Informationen und Anfrage unter: / Informations et demande sous:
glutz.com/manufaktur**

Copyright Glutz AG, © 2023

SCHUTZ-MARKE



MARQUE DÉPOSÉE

AKTIEN-GESELLSCHAFT

V. GLUTZ-BLOTZHEIM NACHFOLGER

SOLOTHURN

SCHWEIZ

ETABLISSEMENT GEGRÜNDET 1860

Album Nr. 3

Drücker, Oliven, Schilder, Knöpfe, Handhaben, Nägel

Poignées, Ecussons, Boutons, Clous

SOCIÉTÉ ANONYME

V. GLUTZ-BLOTZHEIM SUCCESSEURS

SOLEURE

SUISSE

ETABLISSEMENT FONDÉ EN 1860

1883



ZÜRICH

1904

GENÈVE



1896

Gesetzl. geschützte Ausgabe. — Edition déposée.

Gegenstand Objet	Nummer Numéro	Text	Figur	Nummer Numéro	Text	Figur	Nummer Numéro	Text	Figur	Nummer Numéro	Text	Figur
		Seite Page	Seite Page		Seite Page	Seite Page		Seite Page	Seite Page		Seite Page	Seite Page
Drücker - Poignées	0	4	33	30	4	24	58 ¹ / ₂ , 58 ³ / ₄	6	59	111—116	4	22
	1, 2	4	23	30 ¹ / ₂	4	32	59	6	57	121—126	4	26
	3, (3 ¹ / ₄)	5	43	31, 31 ¹ / ₄ , 31 ¹ / ₂	5	42	60, 60 ¹ / ₄ , 60 ¹ / ₂ , 60 ³ / ₄	5	39	131—136	4	29
	4	4	23	32	4	28	61, 61 ¹ / ₄ , 61 ¹ / ₂	5	35	141—146	4	34
	5, (5 ¹ / ₄)	4	24	33	4	23	62	5	44	151—156	4	31
	6, (6a)	4	27	34	4	28	63	6	56	161—166	5	36
	6 ¹ / ₄ , 6 ¹ / ₂ , 6 ³ / ₄	4	28	35	6	56	64, 64 ¹ / ₂	4	32	185—189	6	52
	7, (7a), 7 ¹ / ₄ , 7 ¹ / ₂	4	30	36	4	32	65	4	25	190—191	6	53
	8, 8 ¹ / ₄ , 8 ¹ / ₂ , 8 ³ / ₄	5	42	37	4	28	66	5	44	200—202	3	10
	9, 10	5	43	38	6	56	67, 67 ¹ / ₂	6	57	210—213	3	11
	11	5	35	39	4	24	(68), 68a, 69	6	56	221—223	3	12
	12	4	30	40	5	35	70, 70 ¹ / ₄	5	40	225—227	3	13
	13	4	33	41, 41 ¹ / ₄ , 42, 42 ¹ / ₂	6	57	70 ¹ / ₂ , 70 ³ / ₄	5	41	229—231	3	14
	14, 14 ¹ / ₄ , 14 ¹ / ₂ , 14 ³ / ₄	4	25	43	4	30	71, 72	5	42	232—234	3	15
	15	5	43	44	5	35	73	5	43	235, 236	3	16
	18	5	48	45, 46, 47	4	27	(74), 74 ¹ / ₄ , 74 ¹ / ₂ , 74 ³ / ₄	5	45	238, 239	3	17
	19, 19 ¹ / ₂ , 19 ³ / ₄	4	30	48, 49	4	32	75, 76, 77	5	43	241, 243	3	18
	20, 20 ¹ / ₂	6	50	50, 50 ¹ / ₄ , 50 ¹ / ₂ , 50 ³ / ₄	5	38	78, 79	5	44	245, 246	3	19
	21	4	33	51, 52	5	37	80, 81	6	59	247, 248	3	20
	22, 22 ¹ / ₄	4	23	53, 53 ¹ / ₂	4	33	82-82 ³ / ₄ , 83-83 ³ / ₄	5	44	249, 250	3	21
	23	4	24	(54), 54a	6	56	84	5	45	260—263	6	54
	24	6	51	55	5	37	85, 86	5	46	264—267	6	55
	25, 25 ¹ / ₂	6	50	56, 56 ¹ / ₂	5	44	87, 88, 89, 90	5	47	274—279	7	60
	26, 26 ¹ / ₂	5	37	57, 57a, 57 ¹ / ₄	6	58	91, 92, 93	5	48	280, 281	7	61
	27, 27 ¹ / ₂	6	51	57 ¹ / ₂ , 57 ³ / ₄	6	59	94, 95, 96	5	49	292, 293	7	61
	28, 29	4	24	58, 58a, 58 ¹ / ₄	6	58	97, 98	6	50	298, 299	7	61
	Oliven - Boutons	300—303	7	62	315—322	7	63	344—349	7	65	374—379	7
305—307		7	62	324—329	7	64	354—359	7	65	384—389	7	67
310—313		7	63	334—339	7	64	564—369	7	66	394—399	7	67
Schilder - Ecussons	1—3	8	69	7—15	8	69	(29), 30	8	70	34—38	8	72
	4, 5	8	70	18—25	8	68	31—33	8	71	39—43	8	73
Knöpfe - Boutons	500—529	8	74	533—536	8	75	545	8	75	555—559	8	75
Handhaben - Poignées	612—630	9	76	651	9	77	665	9	77	680	9	80
	640, 645	9	76	655	9	77	670, 671	9	78	685	9	80
	650	9	76	660	9	77	675, 676	9	79	690	9	80
Nägel - Clous	1a, 1b, 2a, 2b	9	78	3	9	79	4	9	79	50, 60	9	79

INHALTS-VERZEICHNIS — TABLE DES MATIÈRES

		Text - Texte		Figuren - Figures	
		Seite	Page	Seite	Page
A. Drücker - Poignées	a) Ganz Metall — <i>Entièrement Métal</i>	3—6		10—53	
	b) Metall-Horn — <i>Métal-Corne</i>	6		54—59	
	c) Ganz Horn — <i>Entièrement Corne</i>	7		60	
	d) Diverse Materialien — <i>Matériaux divers</i>	7		61	
B. Oliven - Boufons	a) Ganz Metall — <i>Entièrement Métal</i>	7		62—65	
	b) Metall-Horn — <i>Métal-Corne</i>	7		66—67	
C. Schilder - Écussons	8		68—73	
D. Knöpfe - Boufons	8		74, 75	
E. Handhaben - Poignées	a) Ganz Metall — <i>Entièrement Métal</i>	9		76—79	
	b) Metall-Horn — <i>Métal-Corne</i>	9		80	
F. Nägel - Clous	9		78, 79	

Ausführungsart der dargestellten Gegenstände — Manière d'exécution des objets représentés

A. Drücker — Poignées

Abkürzungen: — *Abréviations:*

Die abgebildeten Drücker werden in der in den folgenden Tabellen mit einem Strich | bezeichneten Ausführung gemacht.
Les poignées représentées se font dans l'exécution marquée d'un trait | dans les tables suivantes.

GE = Gusseisen SE = Schmiedeeisen M = Messing RB = Rotbronze WB = Weissbronze
F = Fonte FF = Fer forgé L = Laiton BR = Bronze rouge BB = Bronze blanc

Rosetten: ○ = rund □ = kantig
Rosaces: ○ = ronde □ = carrée

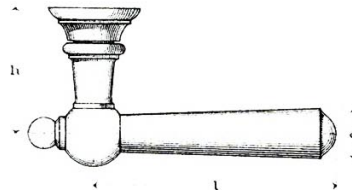

H = Hülse
D = Douille

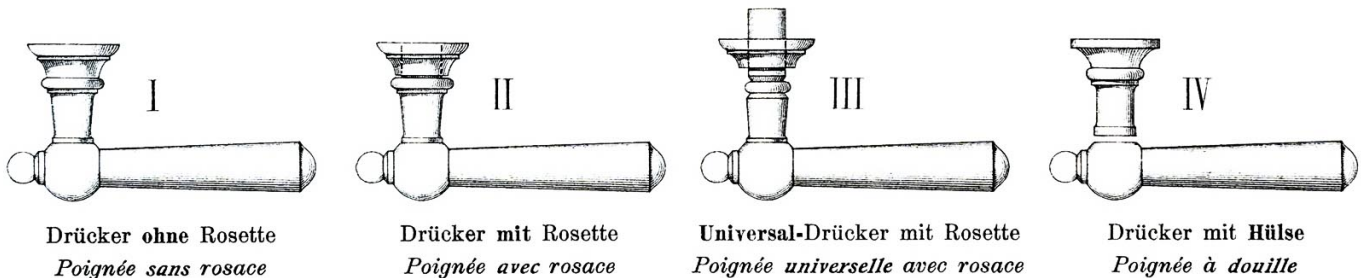

Drücker ohne Rosette
Poignée sans rosace

Drücker mit Rosette
Poignée avec rosace

Universal-Drücker mit Rosette
Poignée universelle avec rosace

Drücker mit Hülse
Poignée à douille

a) Ganz Metall-Drücker — Poignées entièrement Métal

Seite - Page	Nummer - Numéro	I	II	III	IV	Ausführung — Exécution
10	200—202					Schmiedeeisen, schwarz — <i>Fer forgé, noir</i>
11	210—213					Weichguss, schwarz — <i>Fonte malléable, noir</i>
12—21	221—250					Gusseisen, roh, bronziert, verkupfert — <i>Fonte, brute, vernie, cuivrée</i>



c) Ganz Horn-Drücker — Poignées entièrement Corne

Seite Page	Nummer — Numéro	Ausführung — Exécution
60	274, 275, 276, 277, 278, 279	Mit runder Rosette — <i>Avec rosace ronde</i>

d) Drücker aus diversen Materialien — Poignées en matériaux divers

Seite Page	Nummer Numéro	Materialien — Matériaux
61	280	Gusseisen vernickelt und Ebenholz <i>Fonte nickelée et bois d'ébène</i>
	281	Messing pol., Rotbronze pol., Weissbronze vernickelt und Nussbaumholz <i>Laiton poli, Bronze rouge poli, Bronze blanc nickelé et noyer</i>
	292, 293	Messing pol., Rotbronze pol., Weissbronze vernickelt und Porzellan *) <i>Laiton poli, Bronze rouge poli, Bronze blanc nickelé et Porcelaine*)</i>
	298, 299	Gusseisen emailliert *) <i>Fonte émaillée*)</i>

*) Farben: weiss, elfenbein, schwarz
*) *Couleurs: blanche, ivoire, noire*

B. Oliven — Boutons.

Seite Page	Nummer — Numéro	Ausführung — Exécution
62	300—303, 305—307	Messing pol., Rotbronze pol., Weissbronze vernickelt <i>Laiton poli, Bronze rouge poli, Bronze blanc nickelé</i>
63	310, 312, 313, 316—322 312, 315, 316	„ „ „ Gusseisen — <i>Fonte</i>
64	324—329, 334—339	Messing pol., Rotbronze pol., Weissbronze vernickelt <i>Laiton poli, Bronze rouge poli, Bronze blanc nickelé</i>
65	344—349, 354—359	„ „ „
66	364—369, 374—379	Messing pol., Rotbronze pol., Weissbronze vernickelt und Horn <i>Laiton poli, Bronze rouge poli, Bronze blanc nickelé et Corne</i>
67	384—389, 394—399	„ „ „

C. Schilder — Ecussons.

Seite Page	Nummer Numéro	Eisen Fer		Messing Laiton		Bemerkungen Observations	Seite Page	Nummer Numéro	Eisen Fer		Messing Laiton		Bemerkungen Observations	
		Länge Longueur mm	Breite Largeur mm	Länge Longueur mm	Breite Largeur mm				Länge Longueur mm	Breite Largeur mm				
											Rotbronze Bronze rouge	Weissbronze Bronze blanc		Rotbronze Bronze rouge
68	18	—	—	200	73	z. Drücker - p. poignée Nr. 18 " " " 96 horizontal & vertical Mit Muschel — <i>A cuvette</i> " " Flach — <i>Plat</i> " " Mit Muschel — <i>A cuvette</i> " " " "	70	4	215	45	215	45	Mit Muschel — <i>A cuvette</i> " " Flach — <i>Plat</i> " " z. Drücker - p. poignées No. 200/213 " " " 84, 93 etc	
	19	—	—	140	42			4a	255	45	255	45		
	20	120	42	120	42			5	240	42	240	42		
	21	—	—	90	44			5a	280	42	280	42		
	22	—	—	67	37			29	—	—	260	50		
	22a	—	—	73	37			29a	—	—	300	75		
	23	—	—	79	32			30	—	—	260	50		
	24	—	—	56	44			30a	—	—	300	75		
	25	—	—	56	38			71	31	—	—	265		60
	69	1	60	60	65				65	32	—	—		250
2		195	55	195	55	72	33	250	50	—	—			
2a		175	55	175	55		34	—	—	240	30			
3		195	55	195	55	35	—	—	240	33				
3a		175	50	175	50	36	—	—	235	—				
7		—	—	165	32	37	—	—	240	34				
8		—	—	165	32	38	—	—	240	34				
9		—	—	142	32	73	39	—	—	240	45			
10		—	—	135	32		40	—	—	240	38			
14		—	—	55	55		41	—	—	235	34			
15	—	—	58	58	42		—	—	230	34				
							43	—	—	240	38			

D. Knöpfe — Boutons.

Seite Page	Gusseisen — Fonte	Messing — Laiton Rotbronze — Bronze rouge Weissbronze — Bronze blanc	Bemerkungen — Observations
74	No. 505, 506, 507, 508 (65 70 75 80 mm ϕ)	No. 500—509	Mit Stift und Mutter — <i>Avec tige et écrou</i>
75	No. 556, 557, 558, 559 (65 70 75 80 mm ϕ)	" 510—519	" "
		" 520—529	" "
		" 533—536	" "
		" 545	" "
		" 555	" "
			ähnlich Nr. 555 — <i>semblable au No. 555</i>



E. Handhaben – Poignées.

Seite Page	Nummer Numéro	Gerade Droit			Gekröpft Coudé				Mit Holzschrauben Avec des vis à bois		Mit Stift und Mutter Avec tige et écrou	
		<i>l</i> mm	<i>h</i> mm	<i>d</i> mm	<i>l</i> mm	<i>h</i> mm	<i>c</i> mm	<i>d</i> mm	Ros. ○	Ros. □	Ros. ○	Ros. □
76	612	beliebig - à volonté			beliebig - à volonté							
	614	"			"							
	616	"			"							
	618	"			"							
	620	"			"							
	622	"			"							
	624	"			"							
	626	"			"							
	628	"			"							
	630	"			"							
	640	105, 125, 150	45	15	—	—	—	—				
	645	150, 180	55	20	150, 180	55	23	20				
	650	175	70	26	175	70	30	26				
77	651	165	70	24	165	70	27	24				
	655	200	60	23	—	—	—	—				
	660	—	—	—	185	25, 35	40	19				
	665	125	43	15	—	—	—	—				
78	670	260	70	30	—	—	—	—				
	671	200	63	23	—	—	—	—				
79	675	205	75	26	—	—	—	—				
	676	165	55	22	—	—	—	—				
80	680	160, 180, 200, 220	55	25	160, 180, 200, 220	55	23	25				
	685	180, 200, 220, 240	63	25	180, 200, 220, 240	63	20	25				
	690	—	—	—	130, 150	45	18	(25)		()		

Bemerkung: Nr. 612—676 { Messing, Rotbronze, Weissbronze
 Observation: Laiton, Bronze rouge, Bronze blanc
 Nr. 680—690 { Messing-, Rotbronze-, Weissbronze-Horn
 Laiton-, Bronze rouge-, Bronze blanc-Corne

F. Nägel – Clous.

Seite Page	Nummer - Numéro	Metall	—	Métal	Mit Holzschraube Avec vis à bois	Mit Stift und Mutter Avec tige et écrou
78	1a, 1b, 2a, 2b	Messing, Rotbronze	—	Laiton, Bronze rouge		
79	3, 4	" "		" "		
	50, 60	" "		" "		



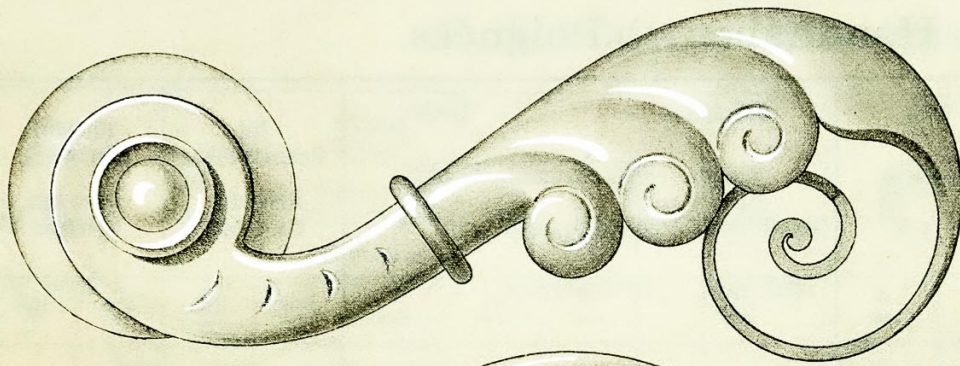

No. 200

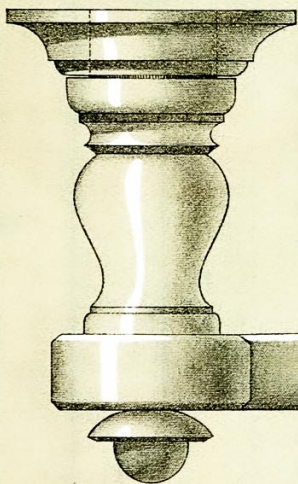
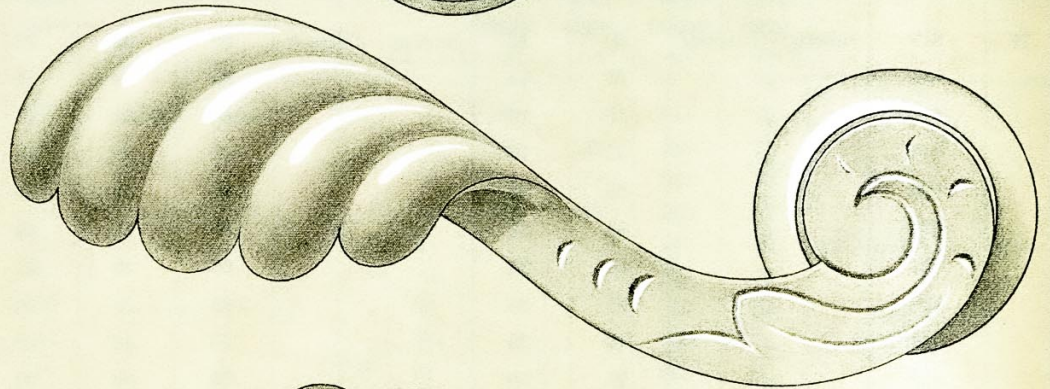

No. 201

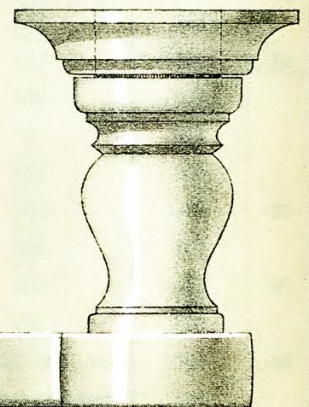
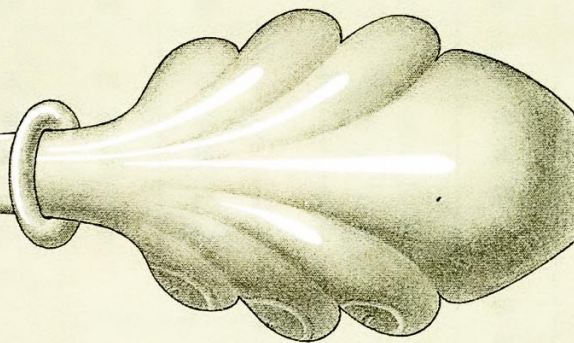

No. 202

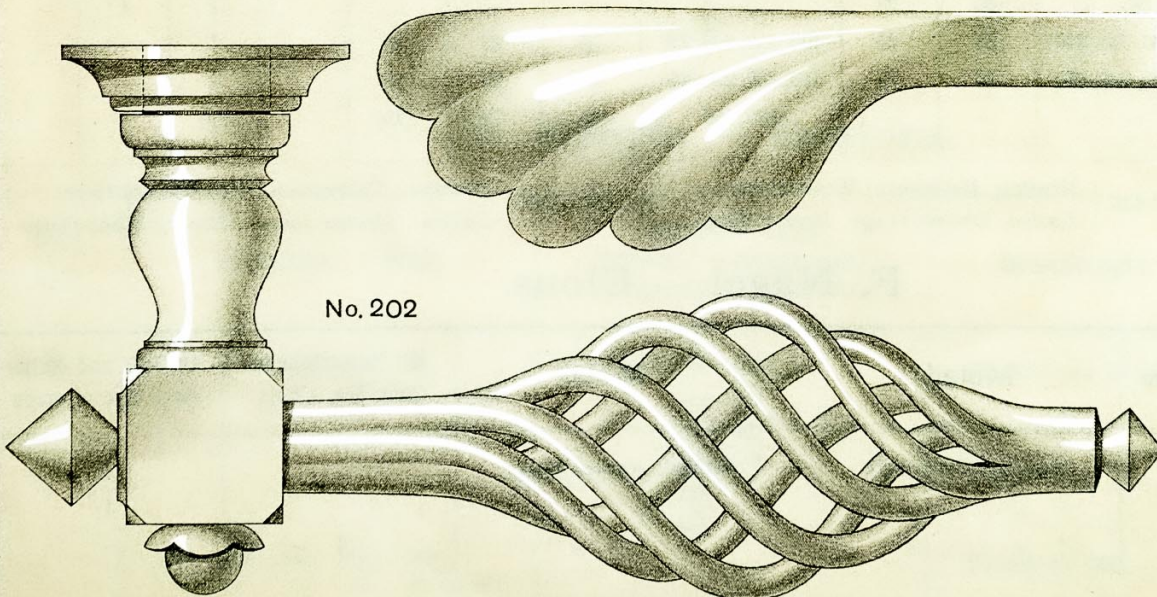

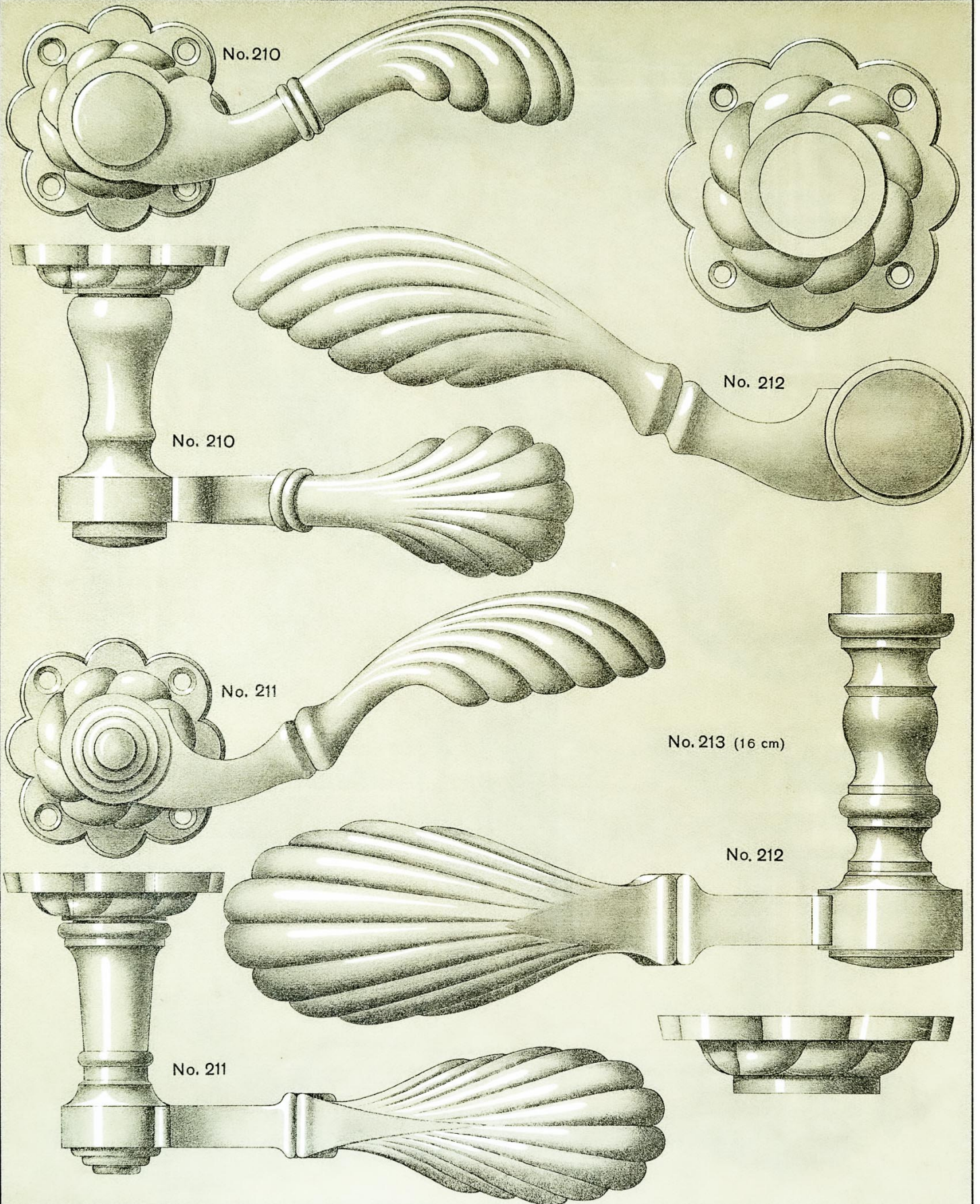

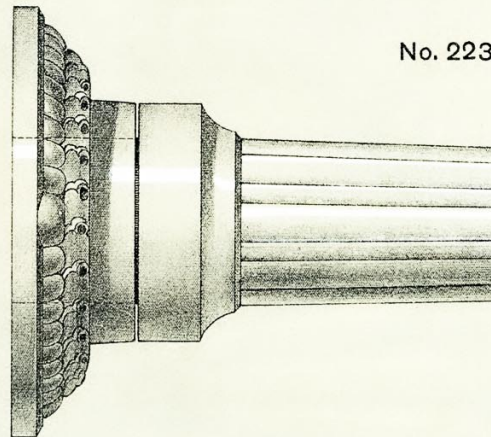
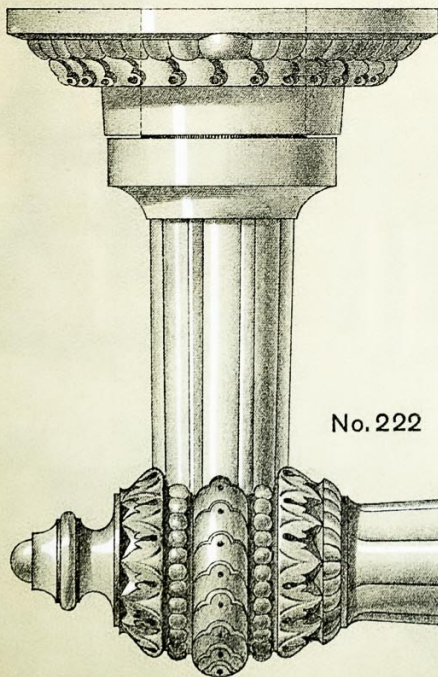
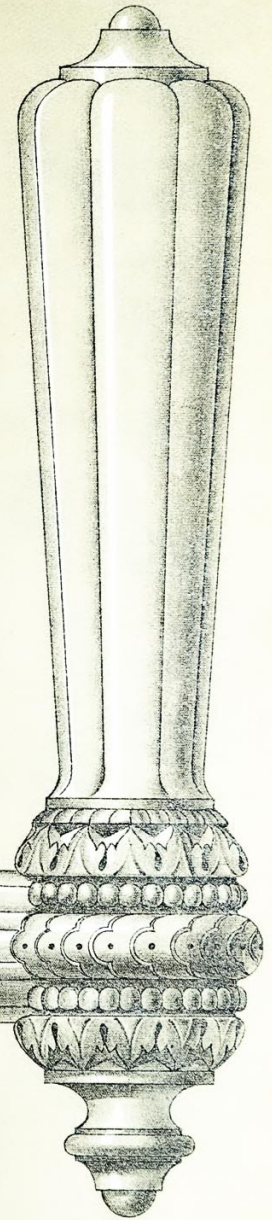
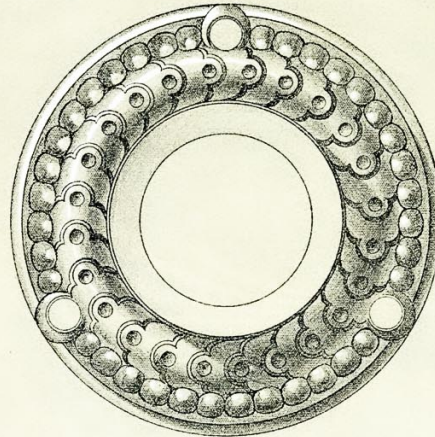
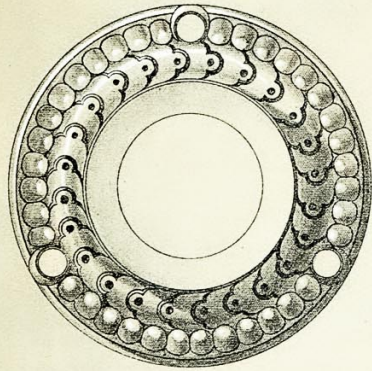
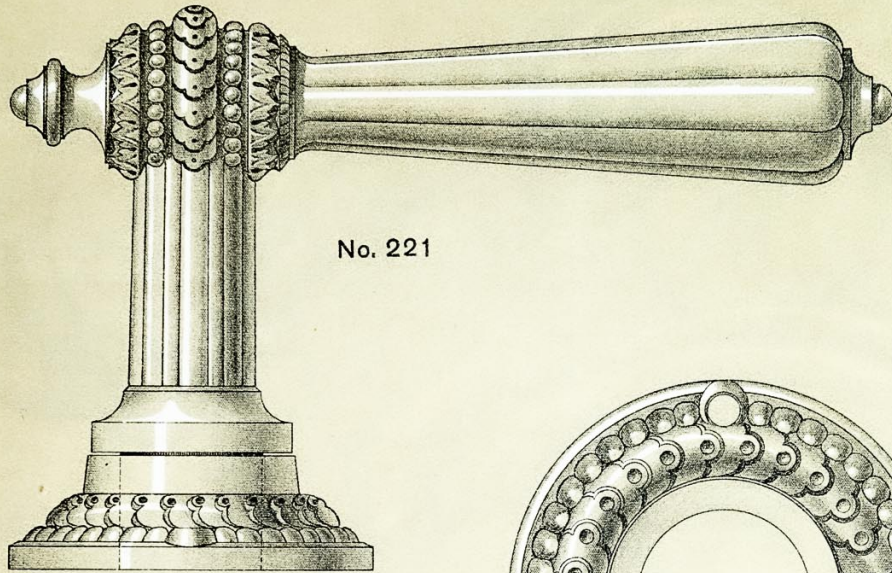

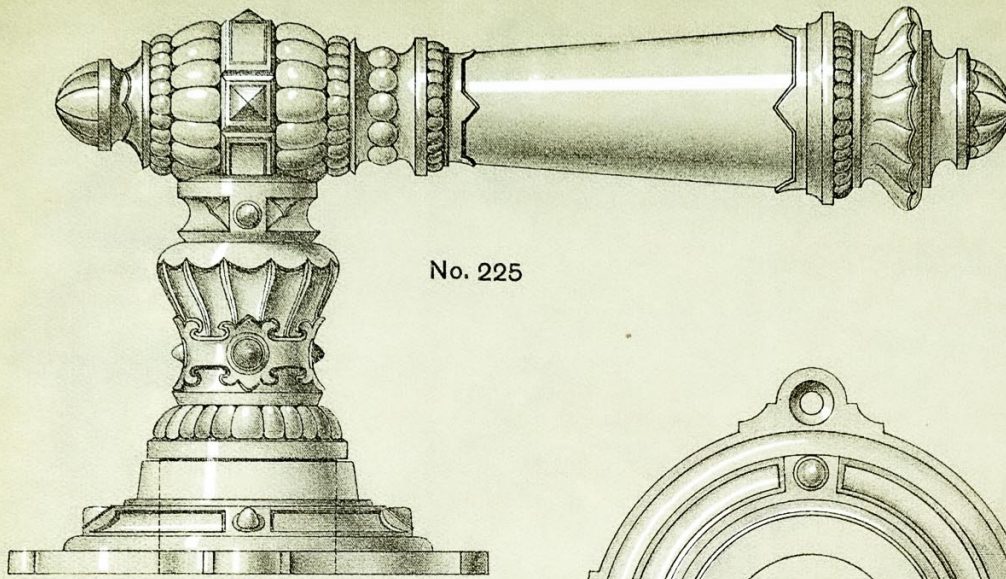

No. 225

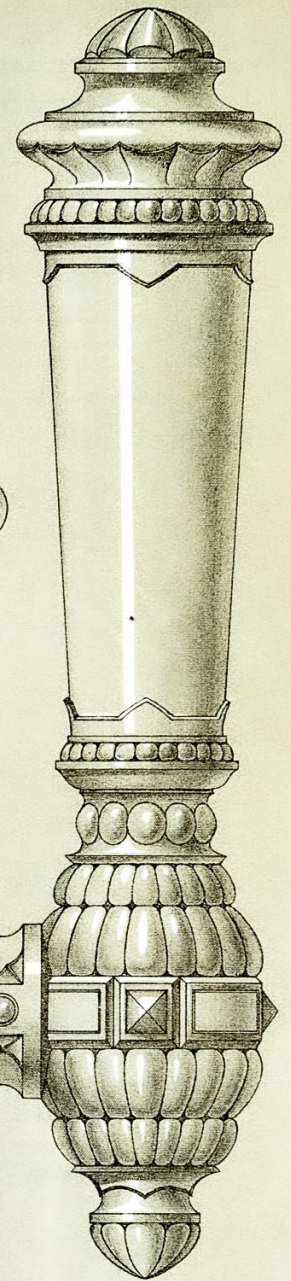

No. 227

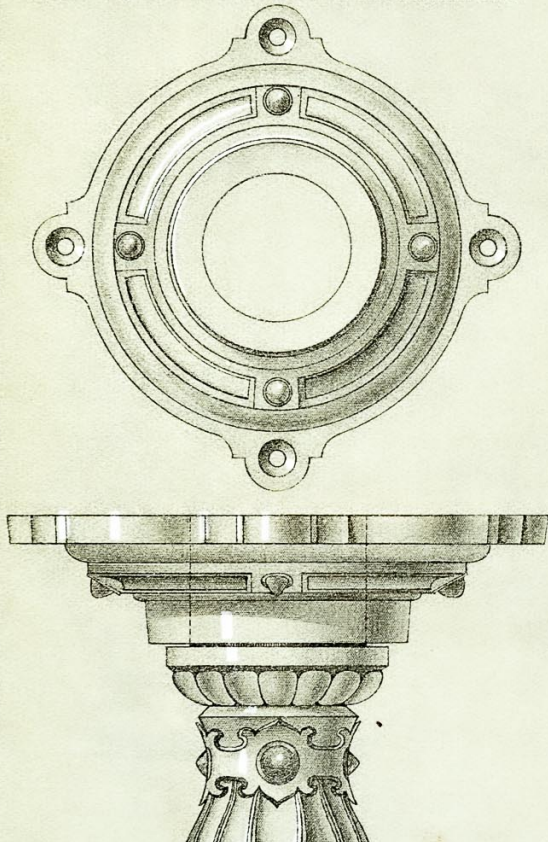

No. 226

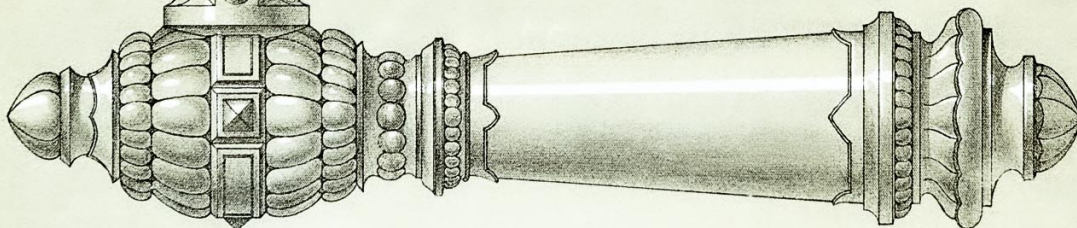

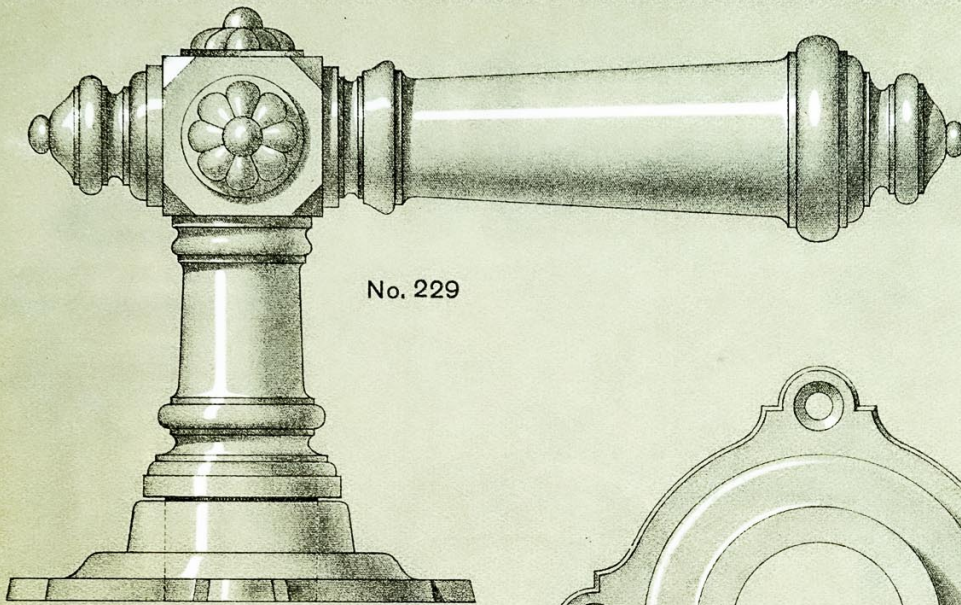

No. 229

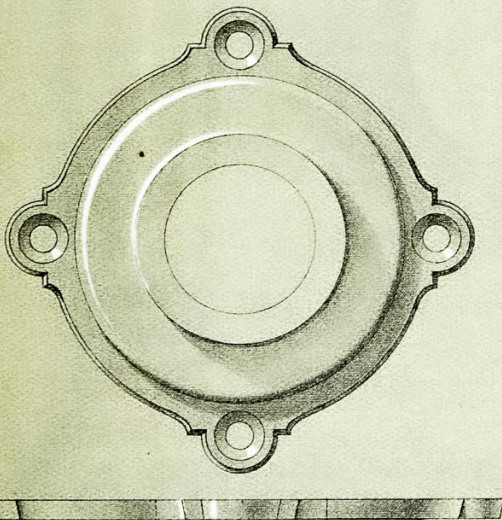

No. 230

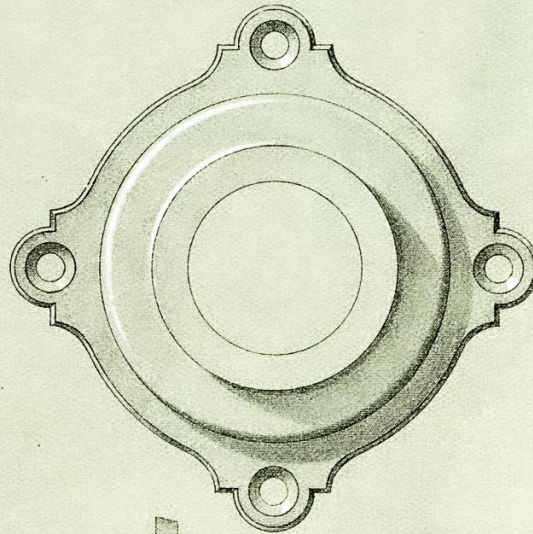

No. 231

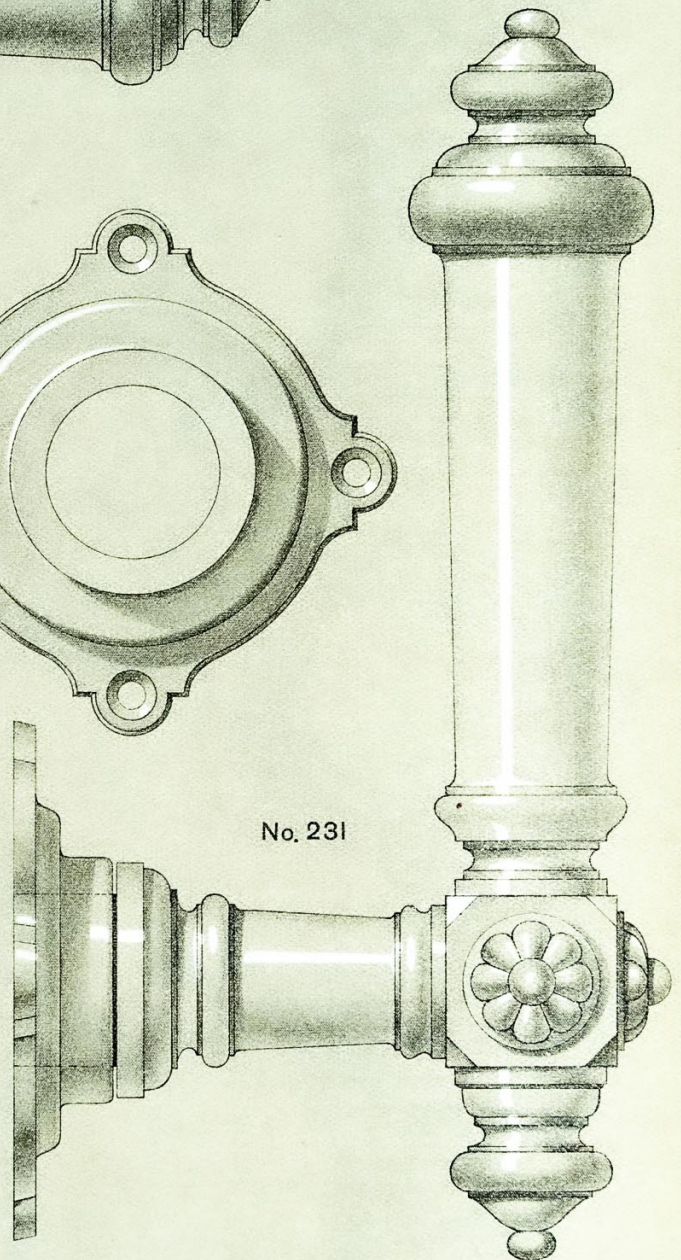

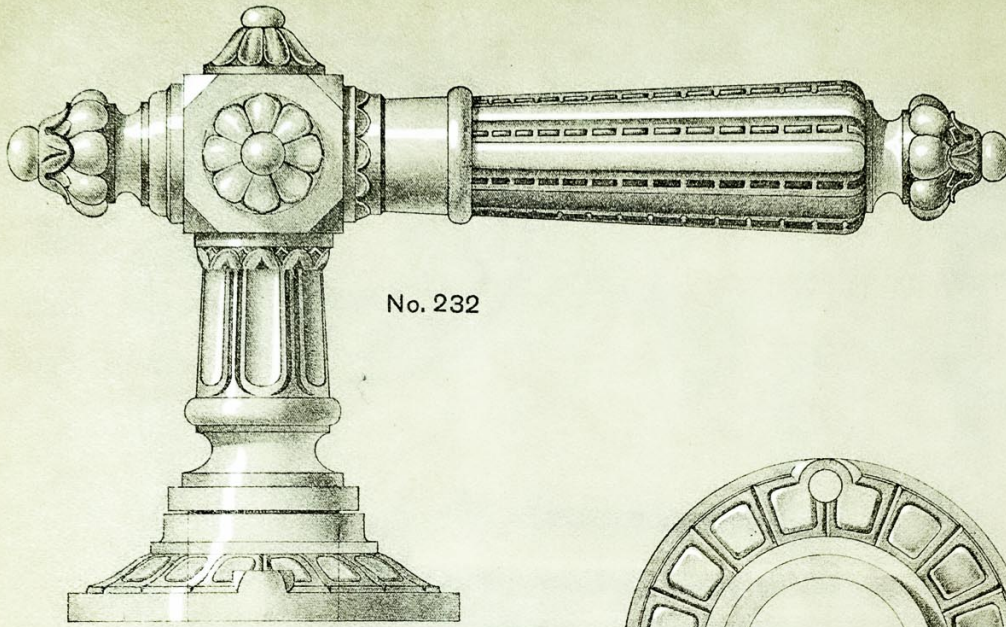

No. 232

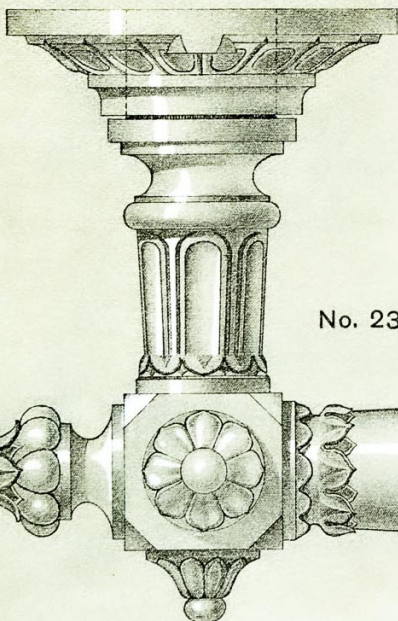
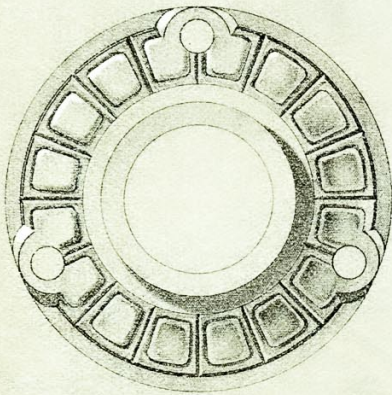

No. 233

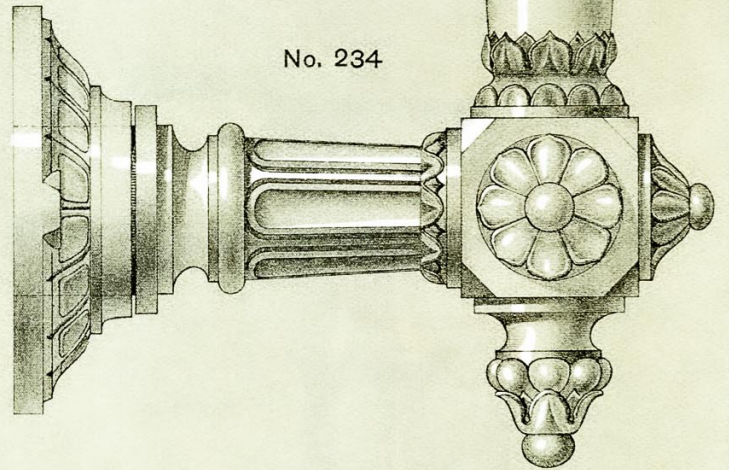
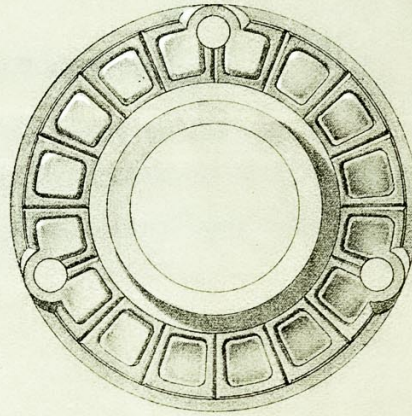

No. 234

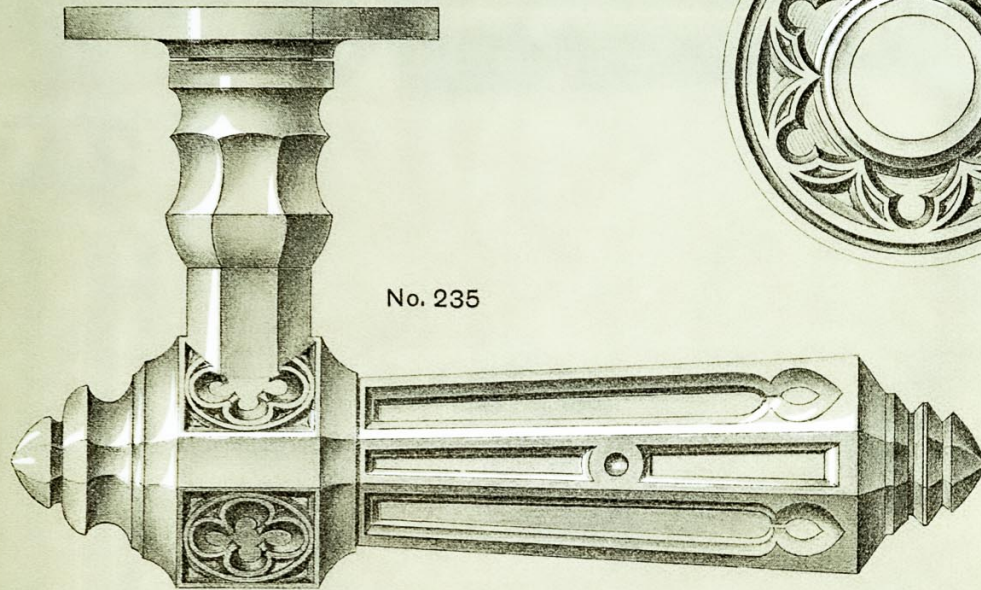

No. 235

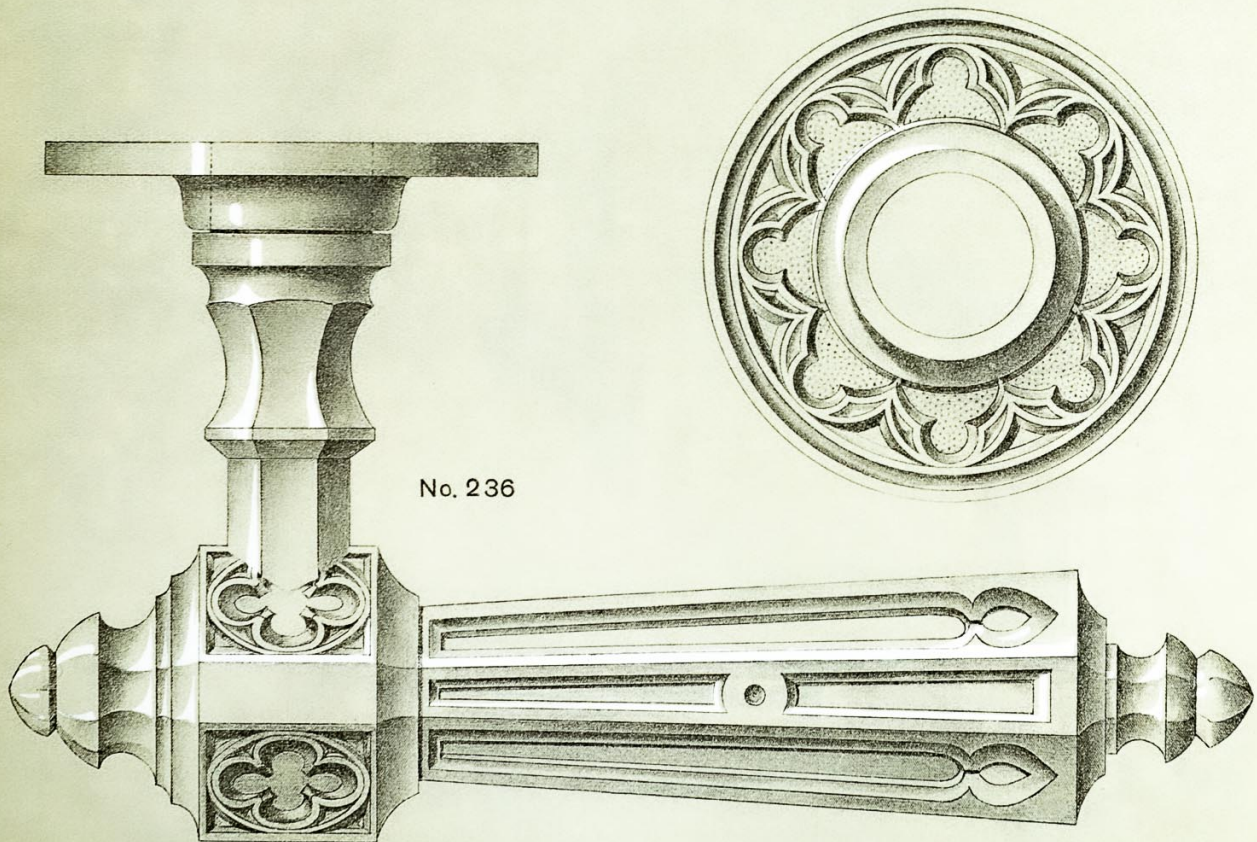

No. 236

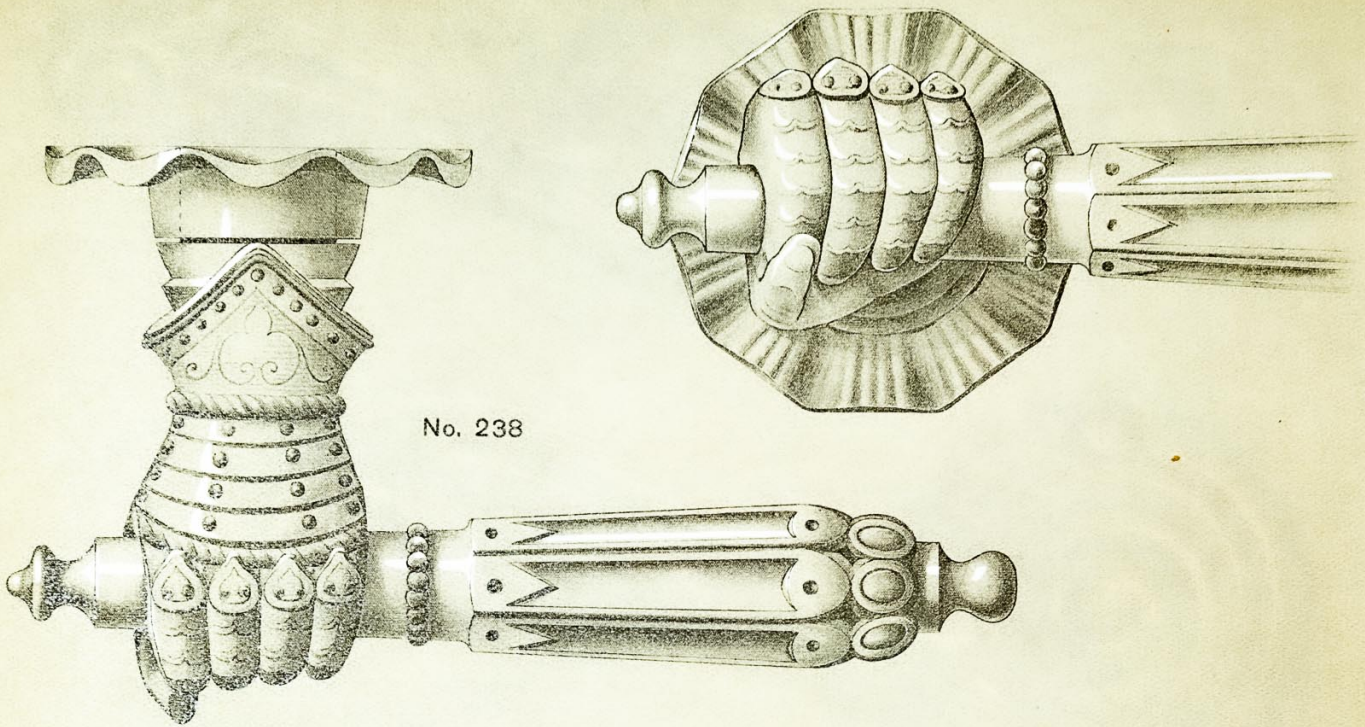

No. 238

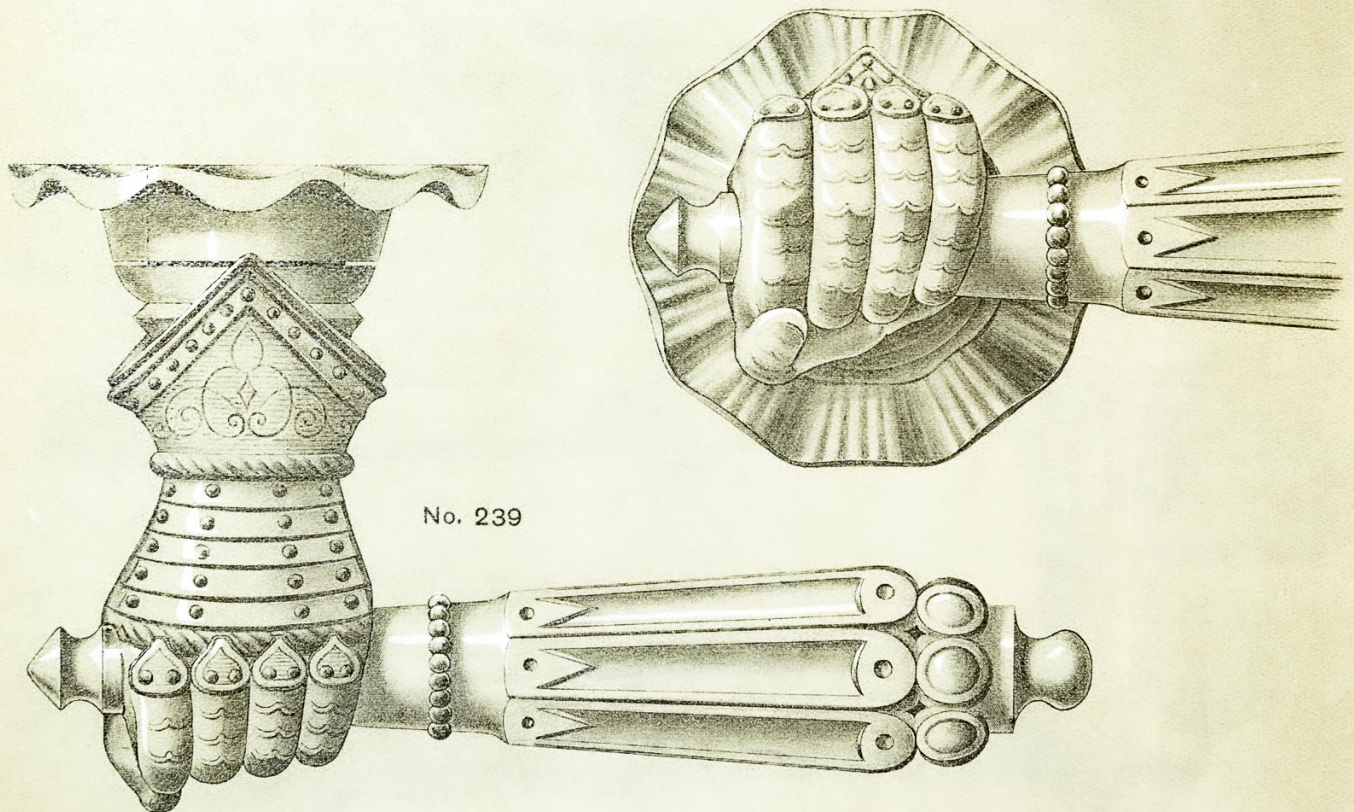

No. 239

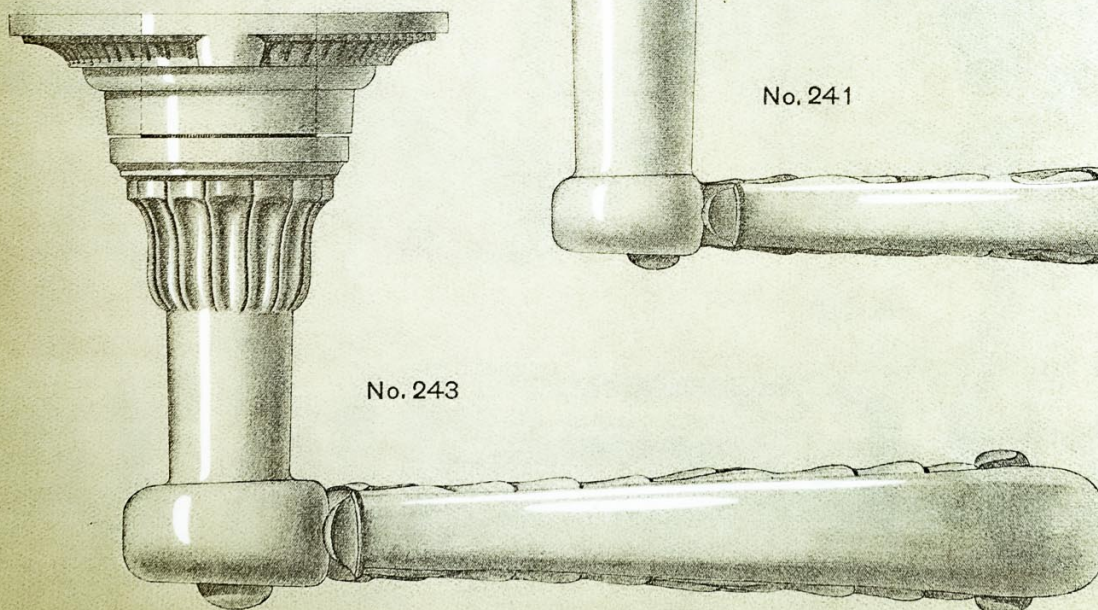
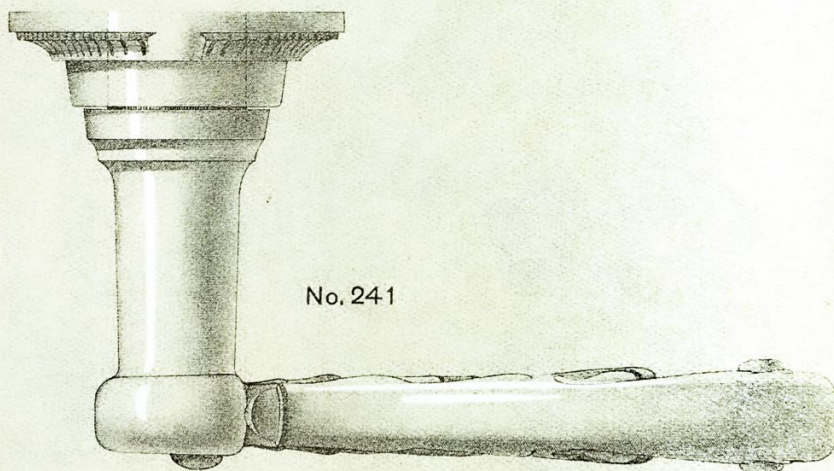
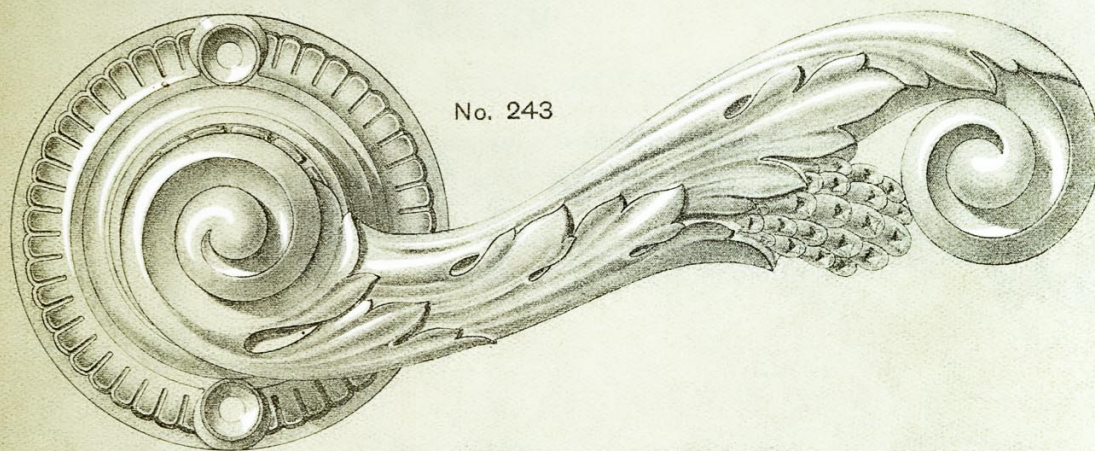
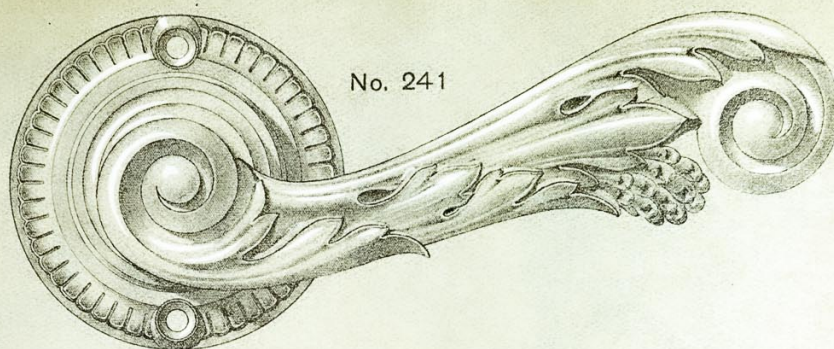

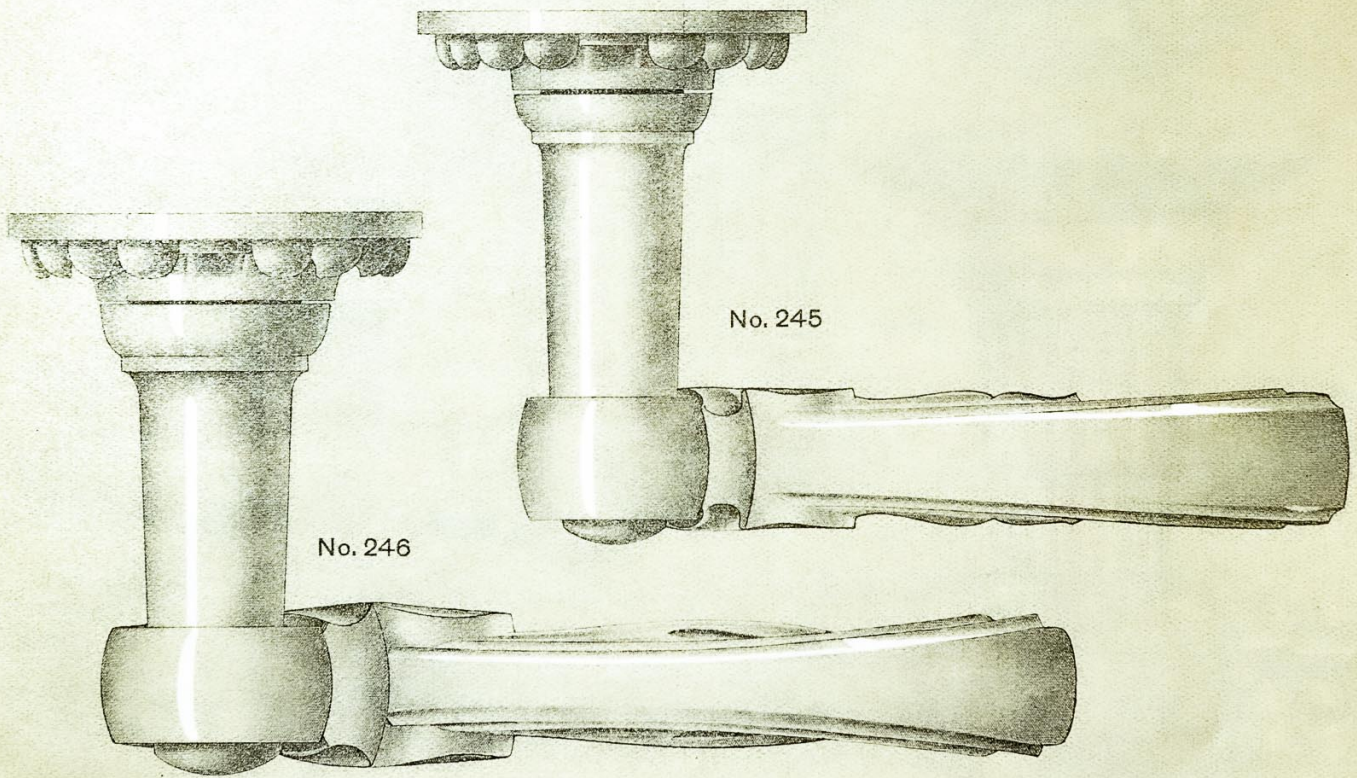
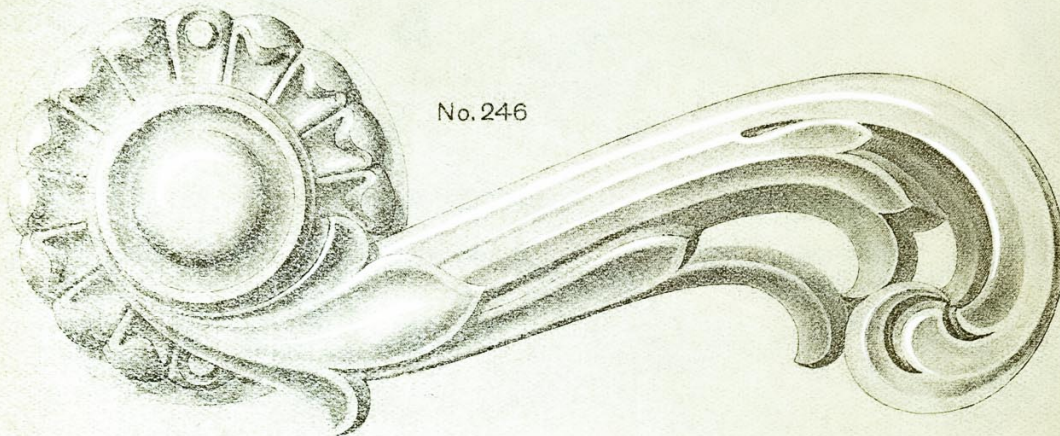
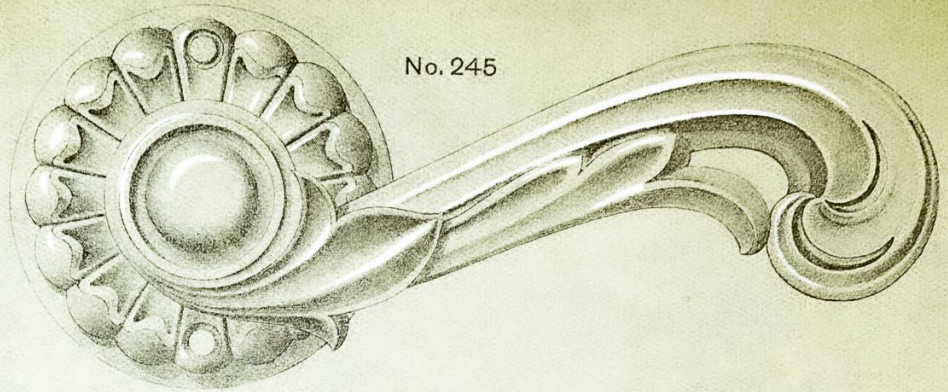

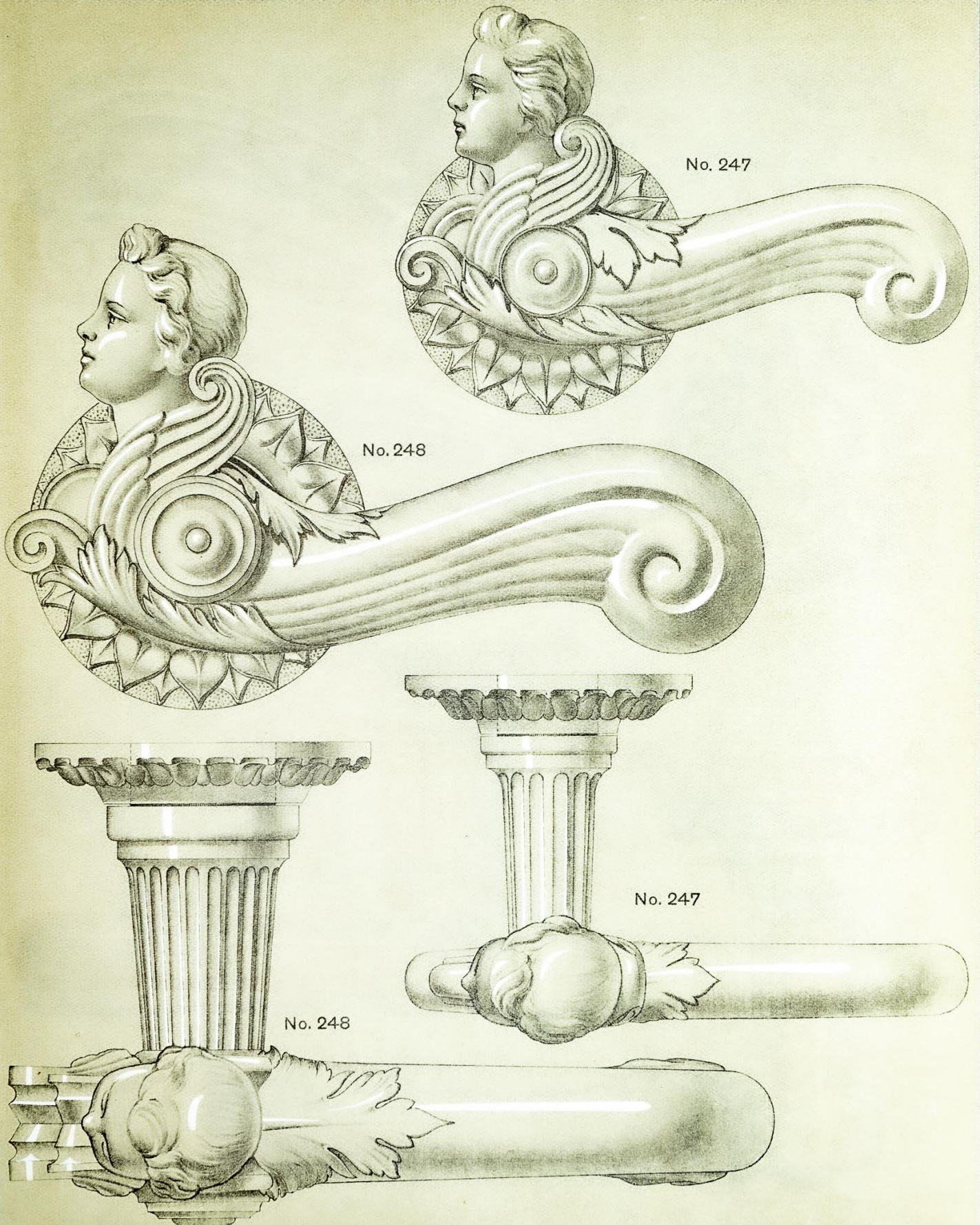

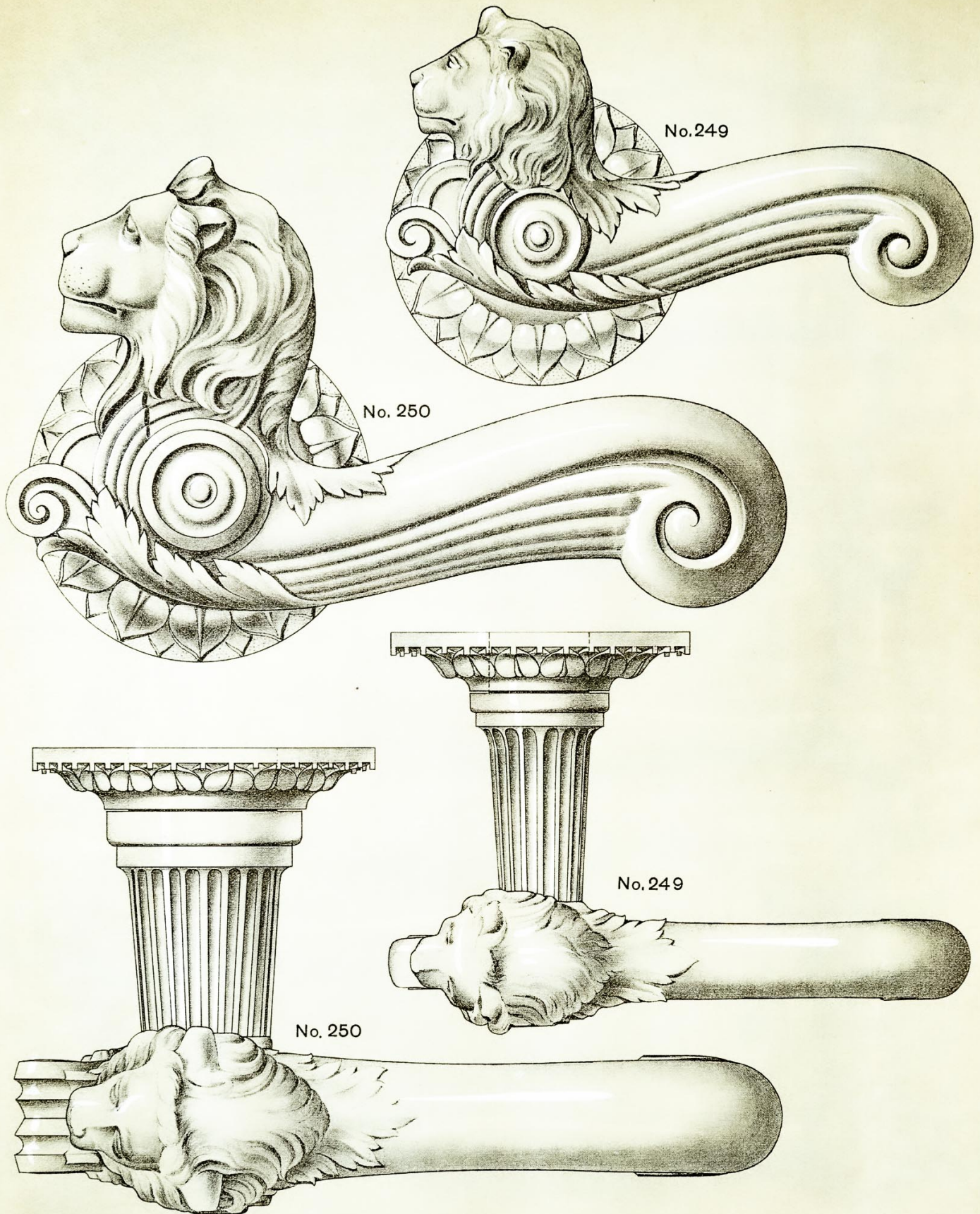

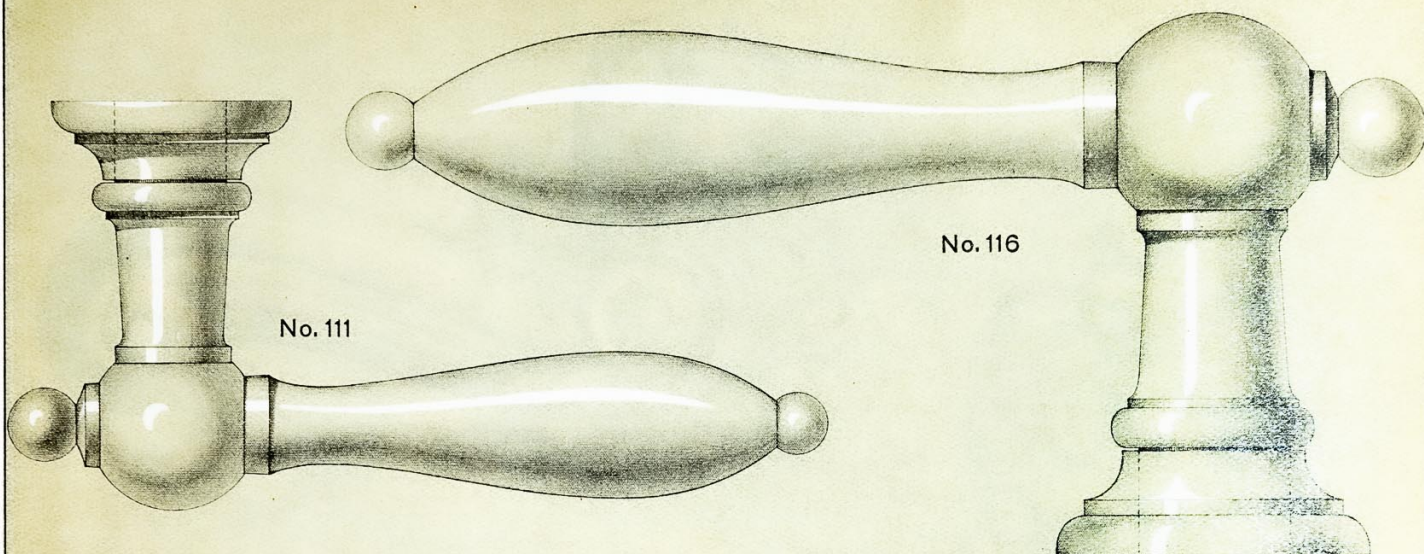

No. 111

No. 116

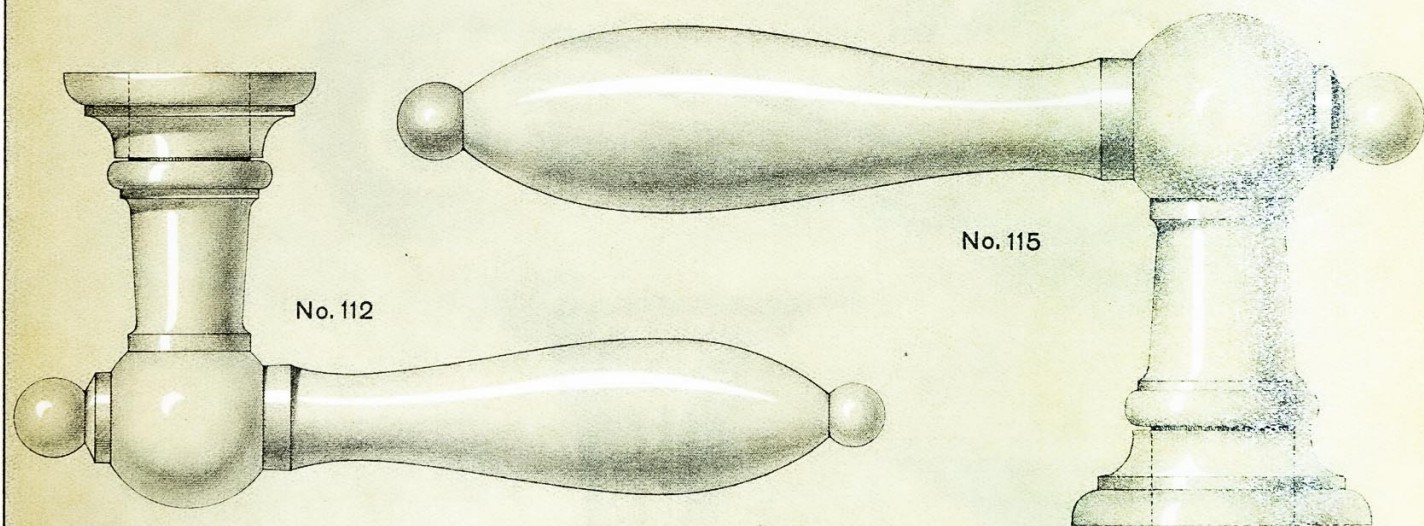

No. 112

No. 115

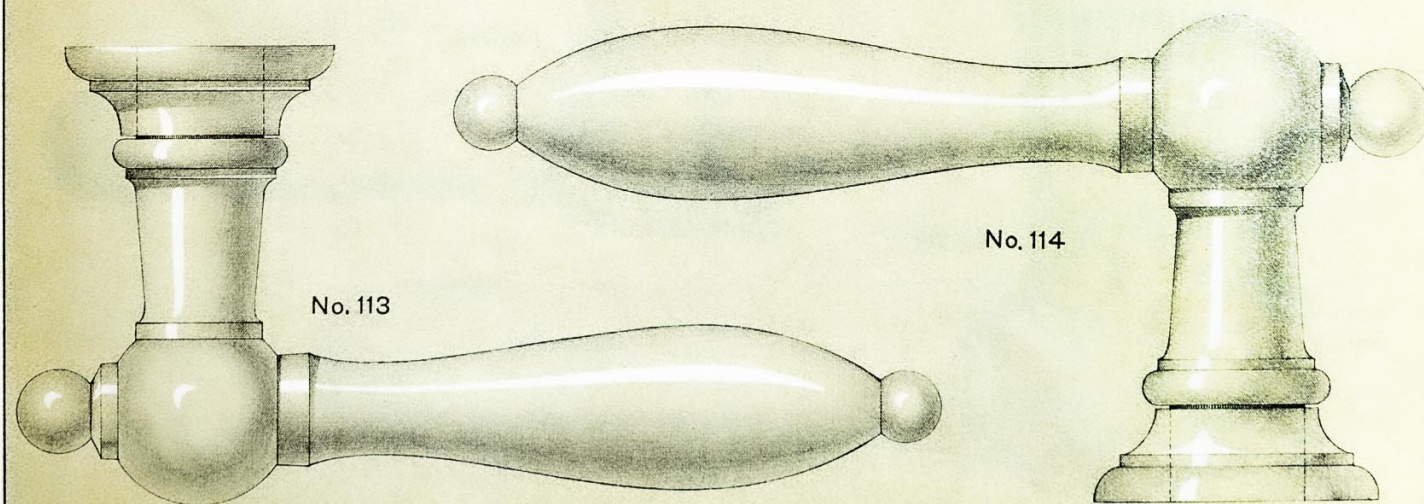

No. 113

No. 114

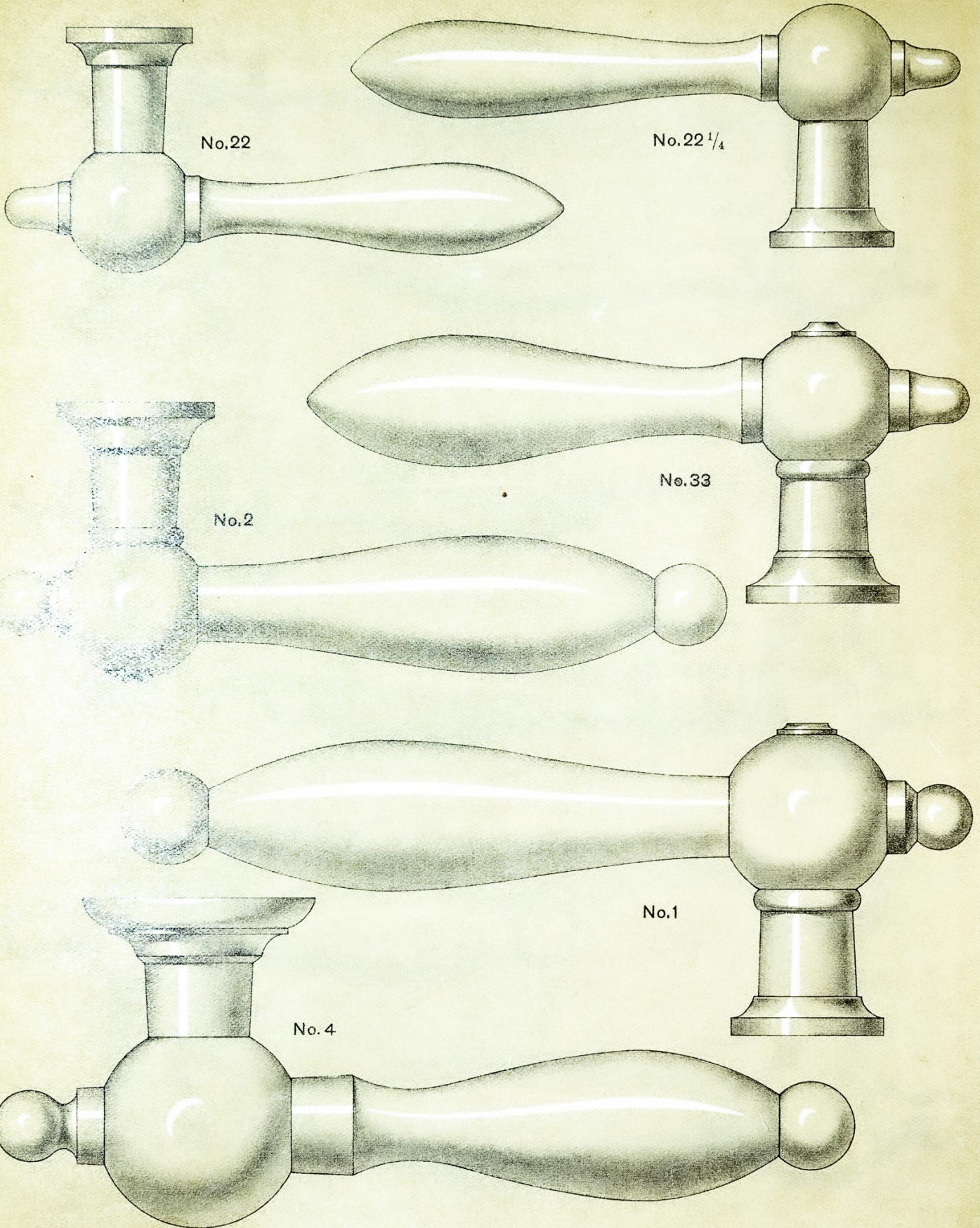

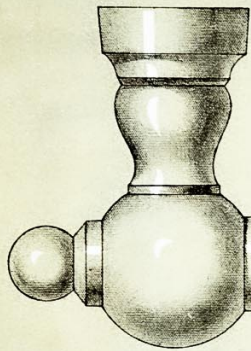

No.39

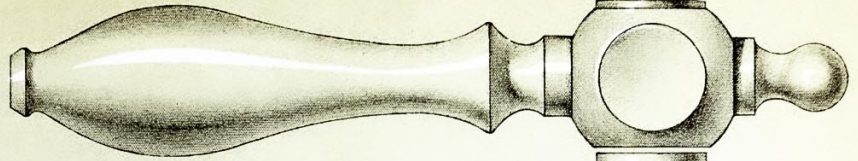

No.30

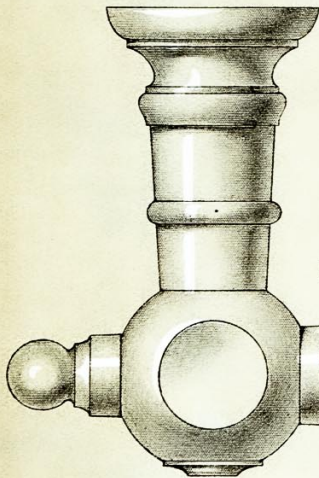
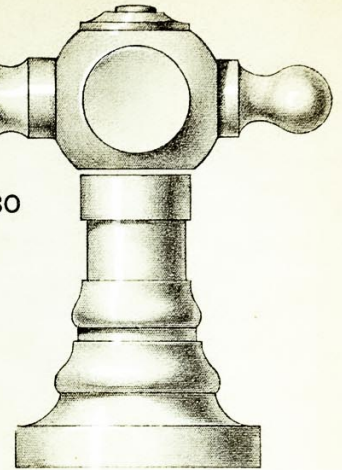

No.29

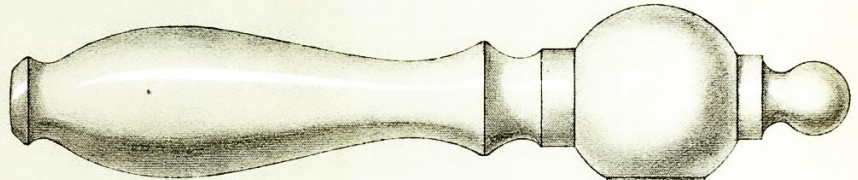

No.28

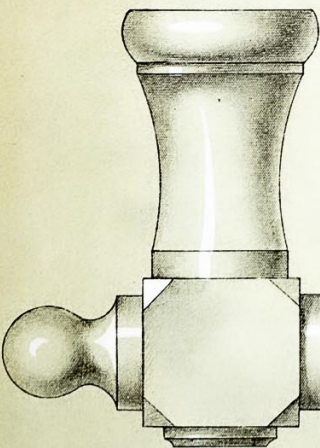
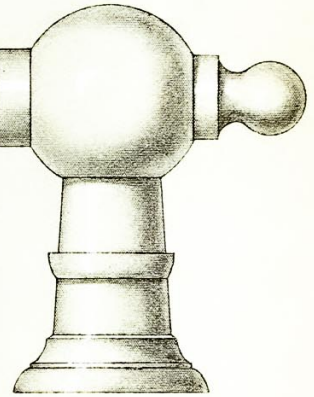

No.5

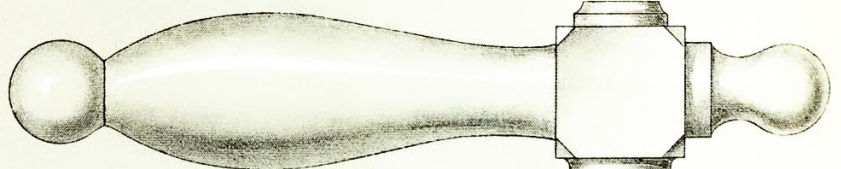

No.23

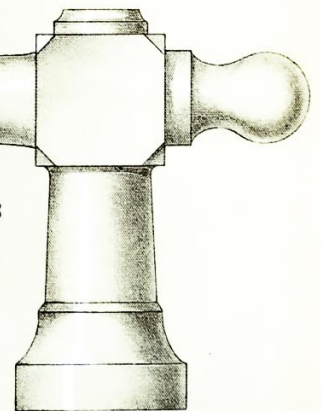

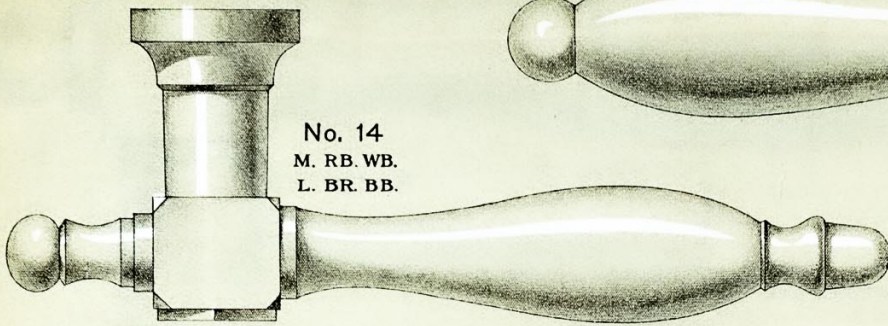

No. 14
M. RB. WB.
L. BR. BB.

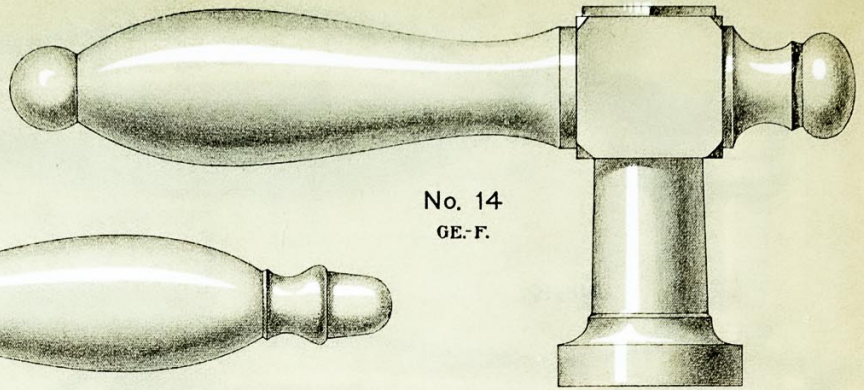

No. 14
GE-F.

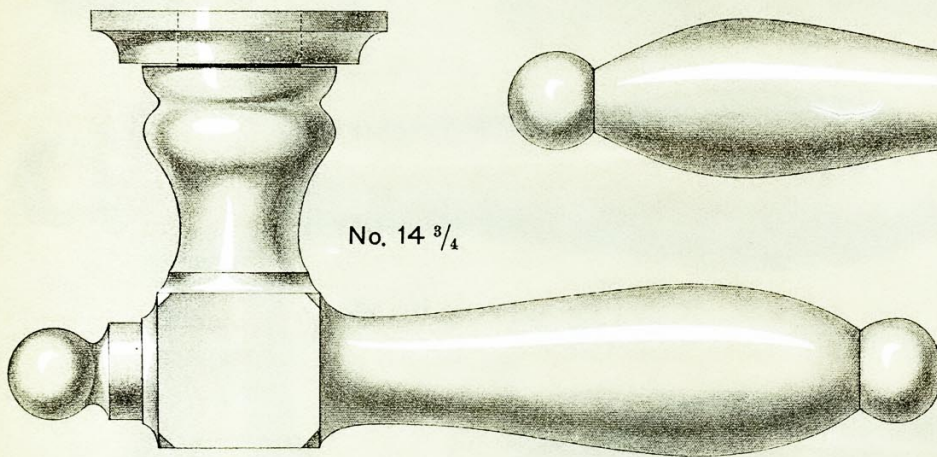

No. 14 ³/₄

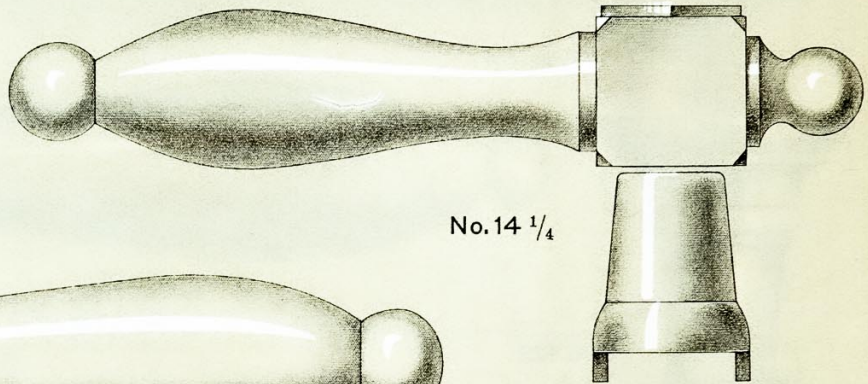

No. 14 ¹/₄

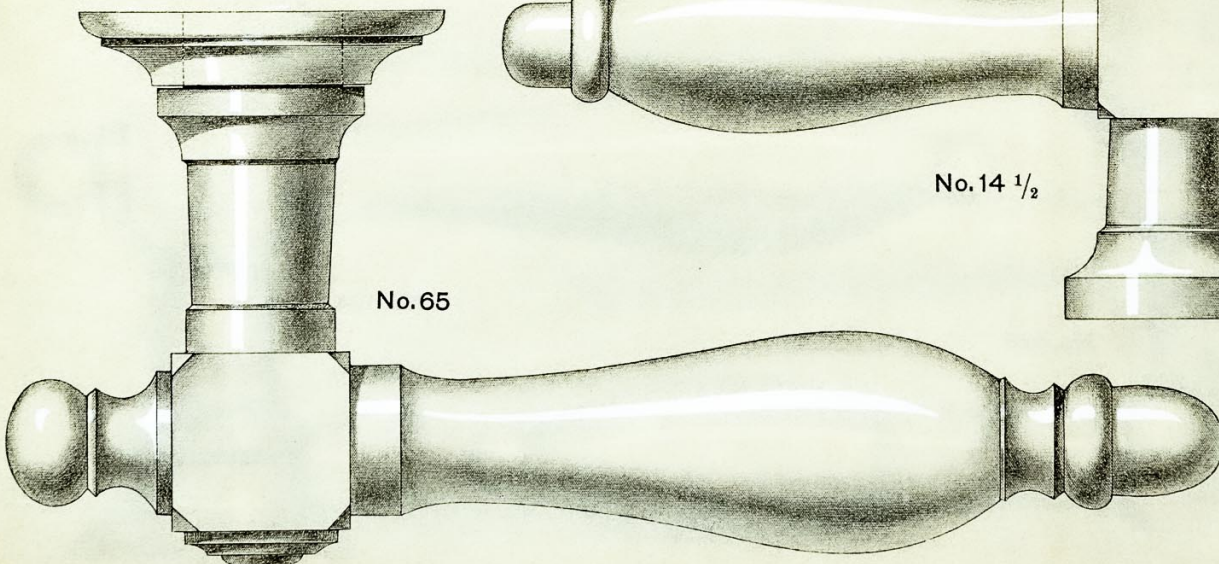

No. 65

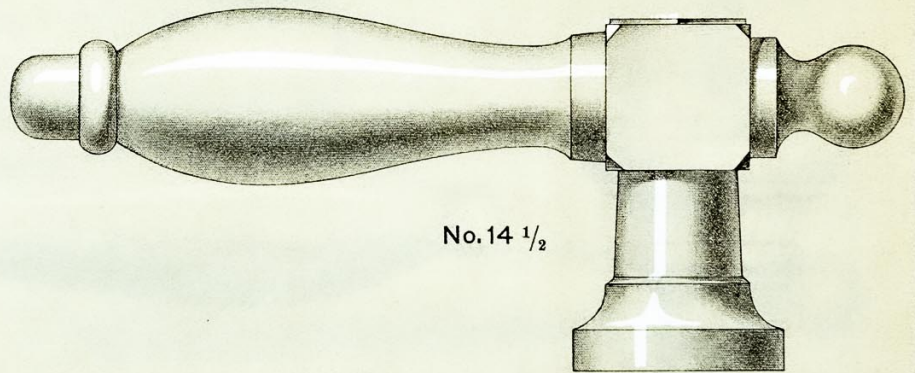

No. 14 ¹/₂

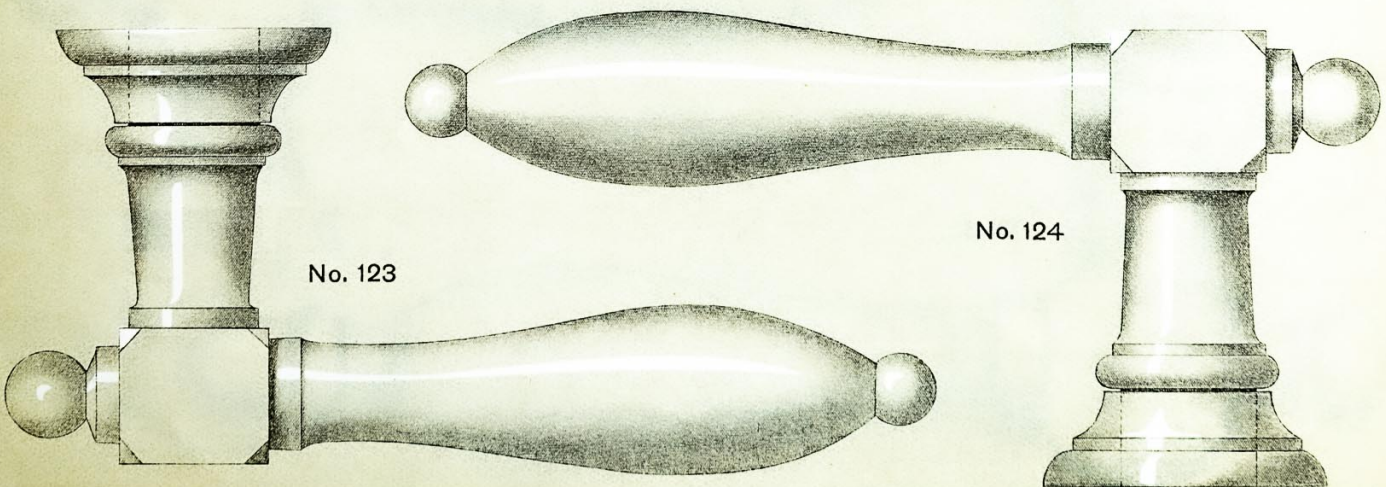
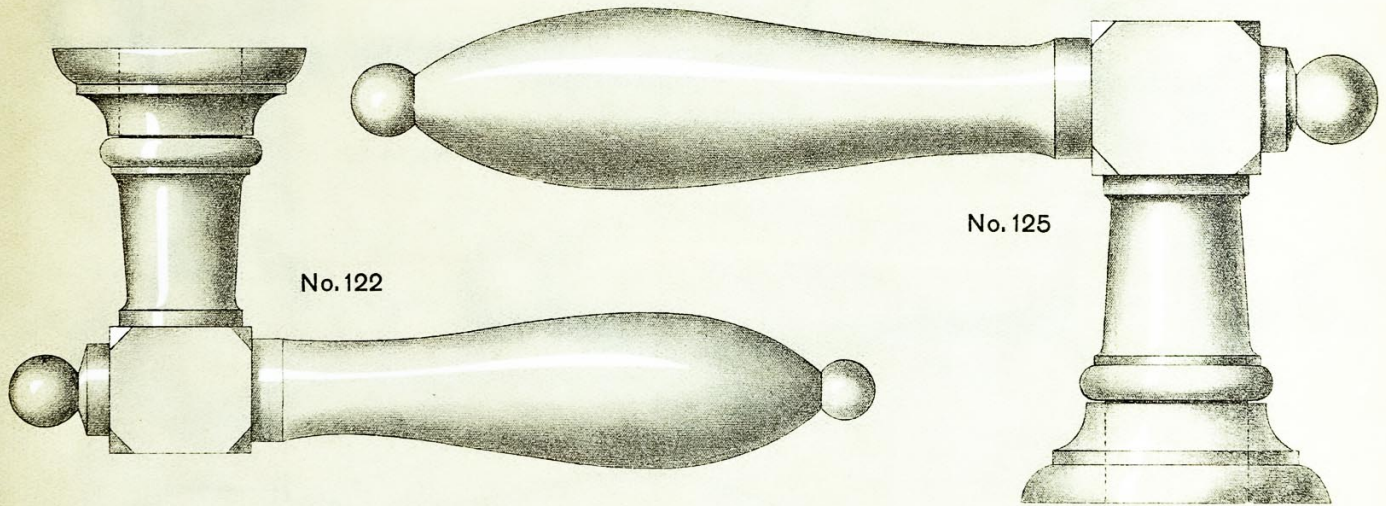
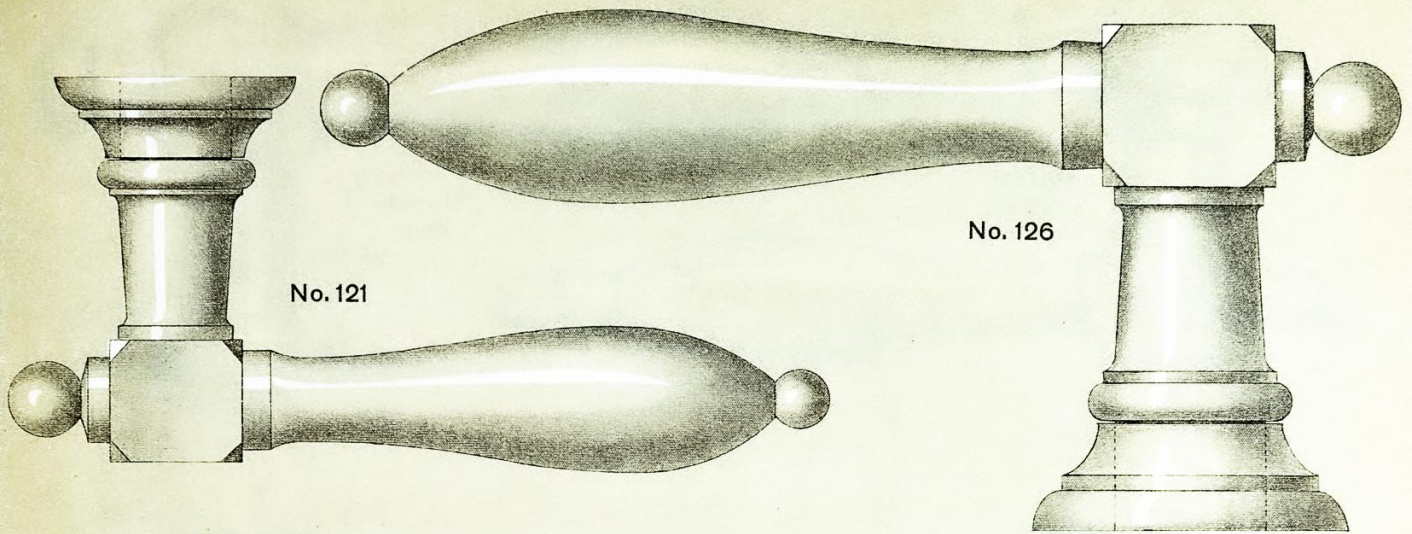

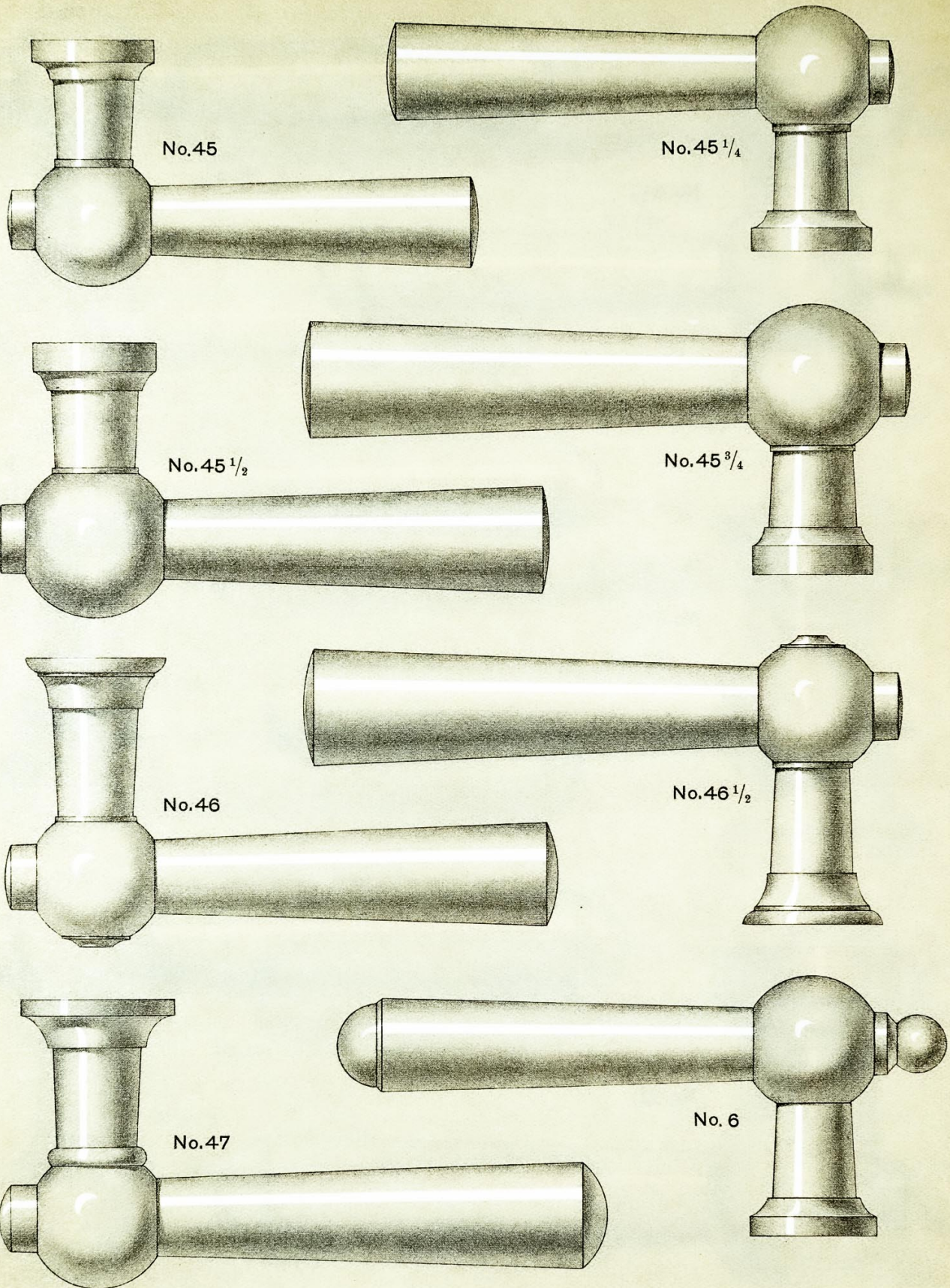

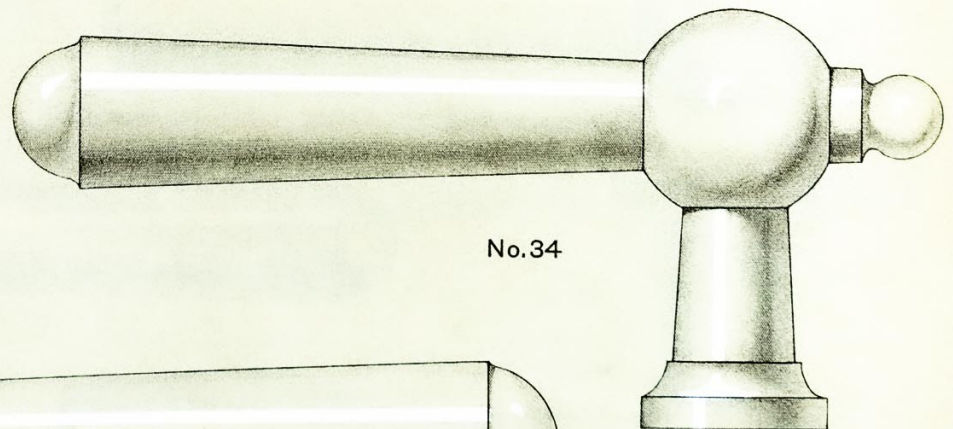
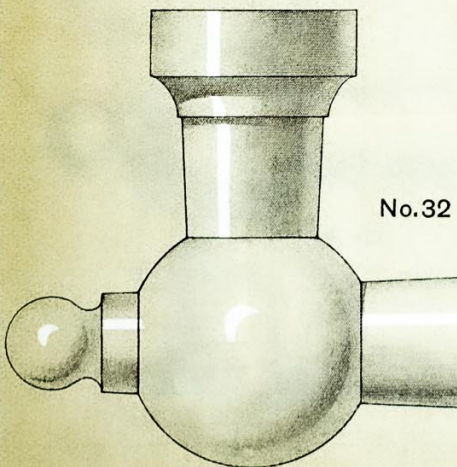
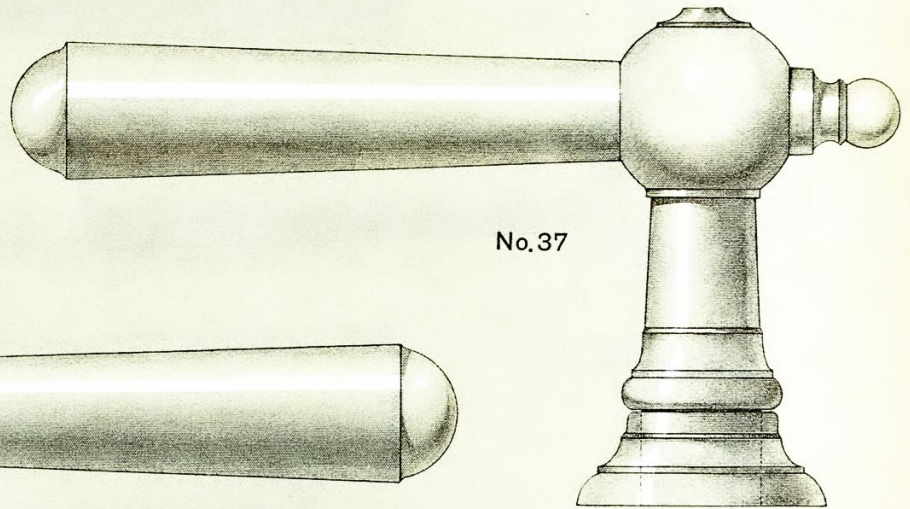
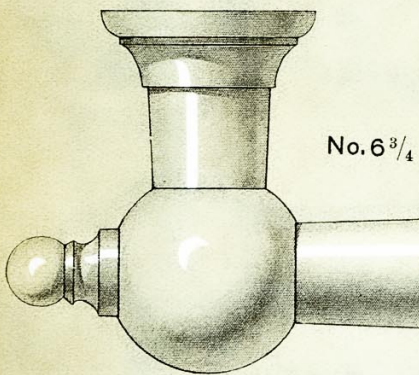
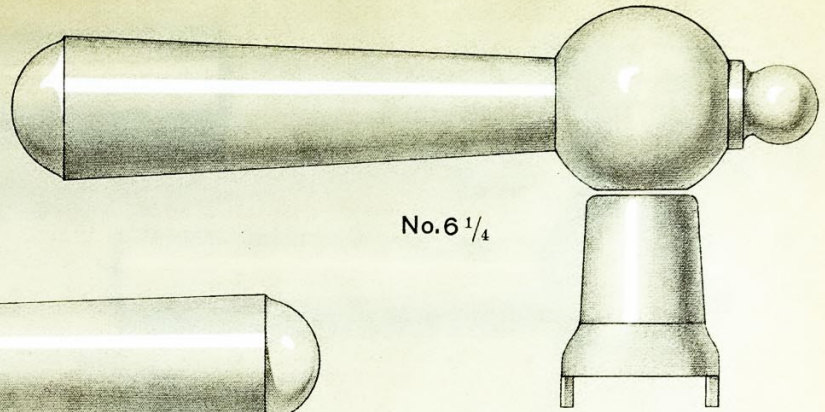
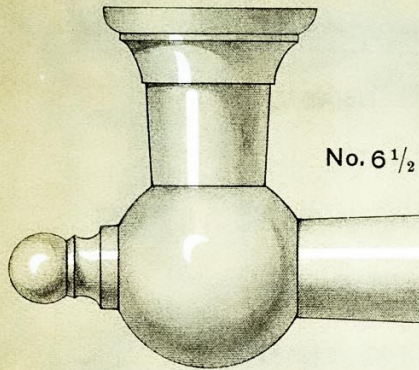

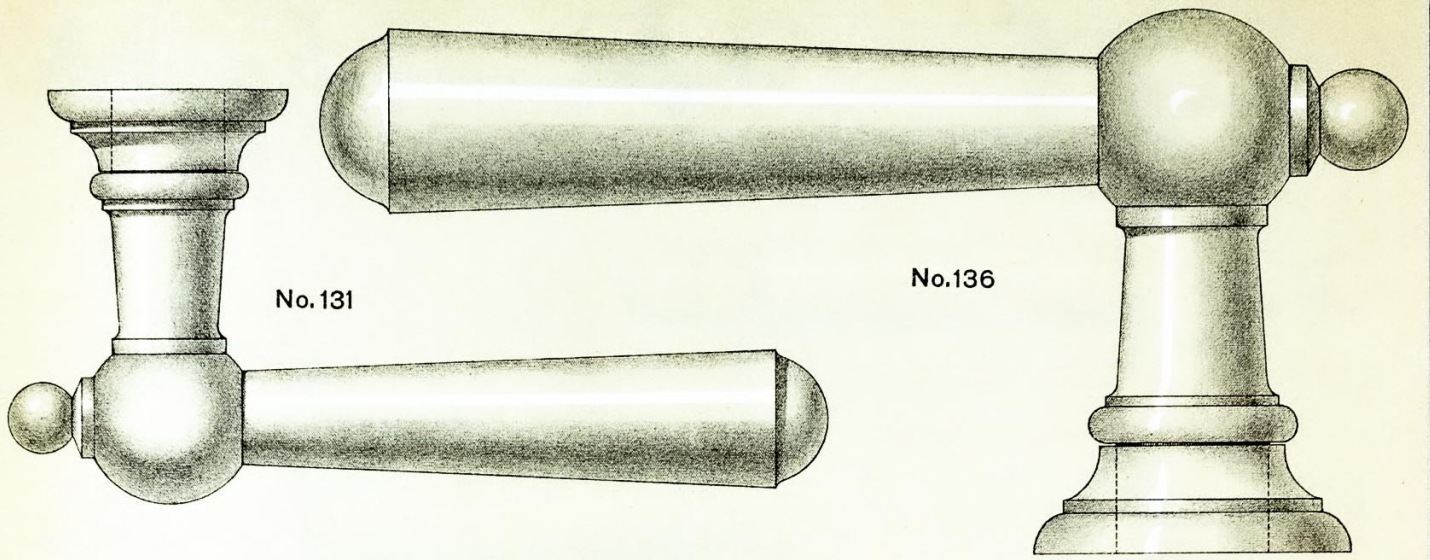

No.131

No.136

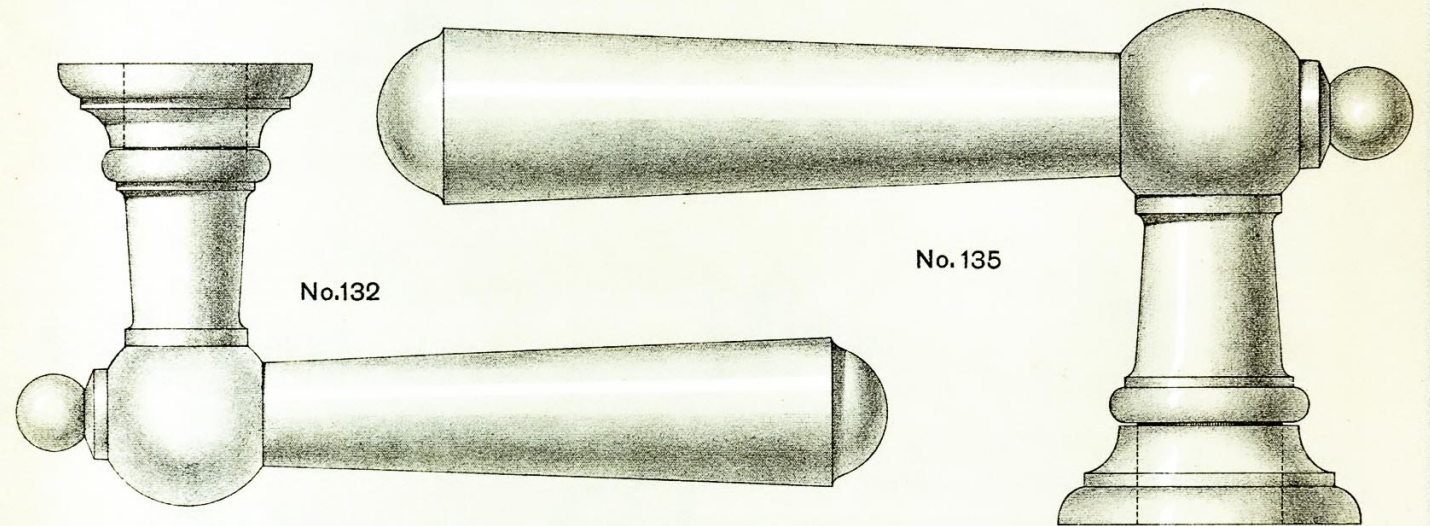

No.132

No.135

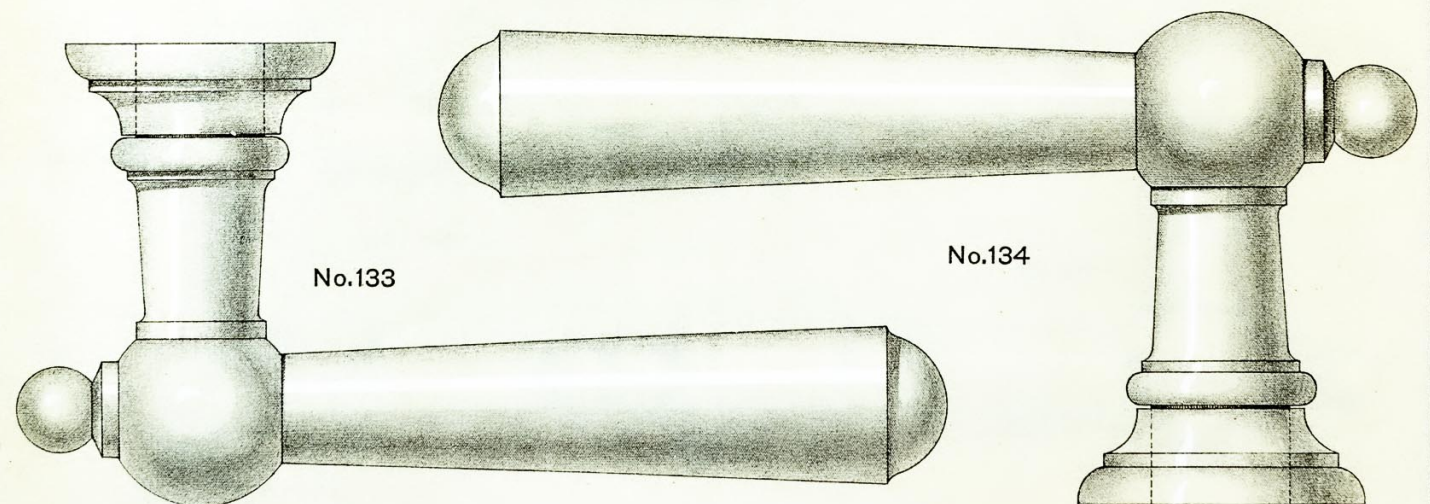

No.133

No.134

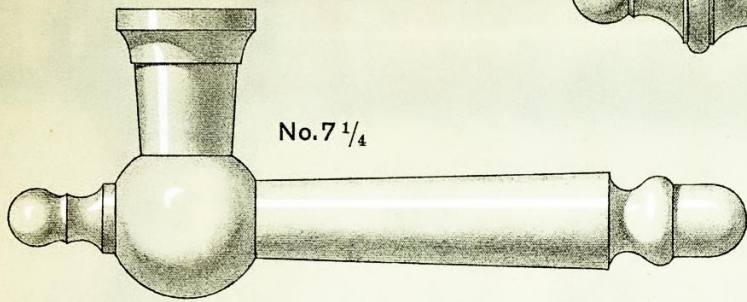

No. 7 1/4

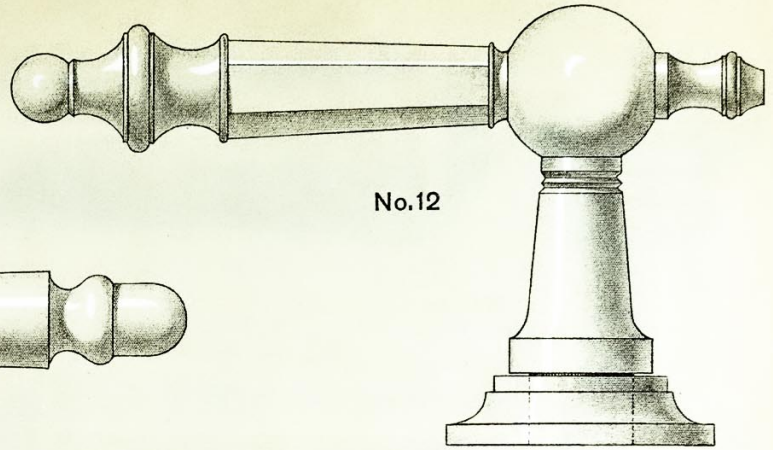

No. 12

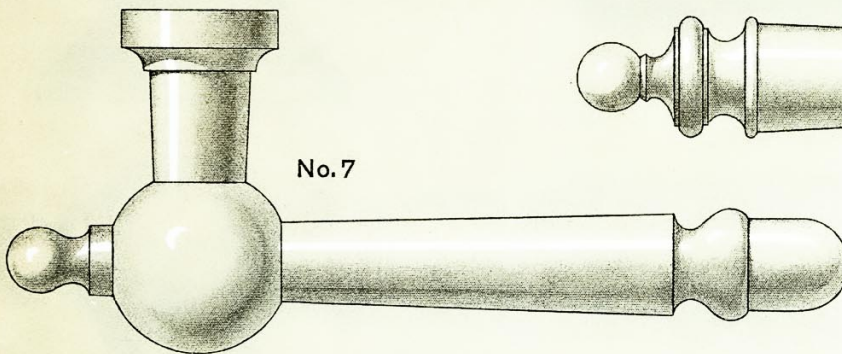

No. 7

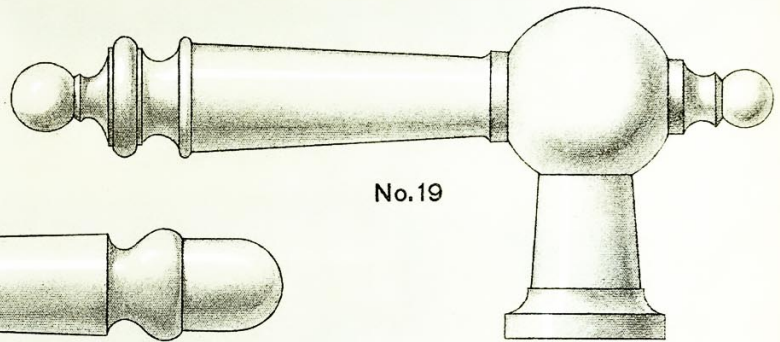

No. 19

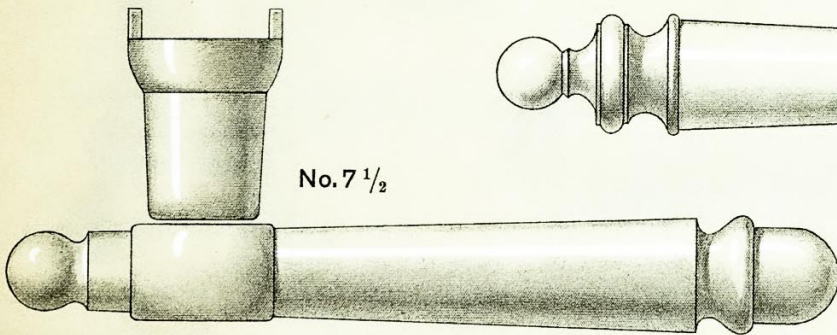

No. 7 1/2

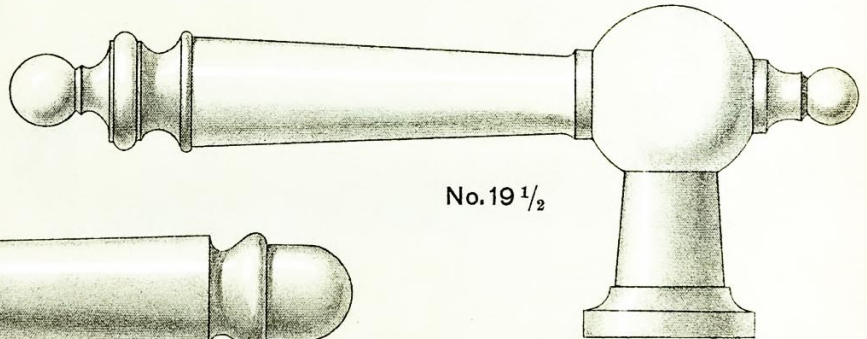

No. 19 1/2

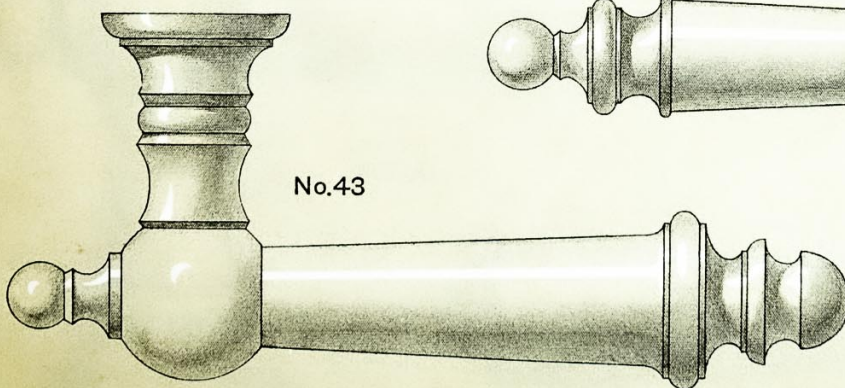

No. 43

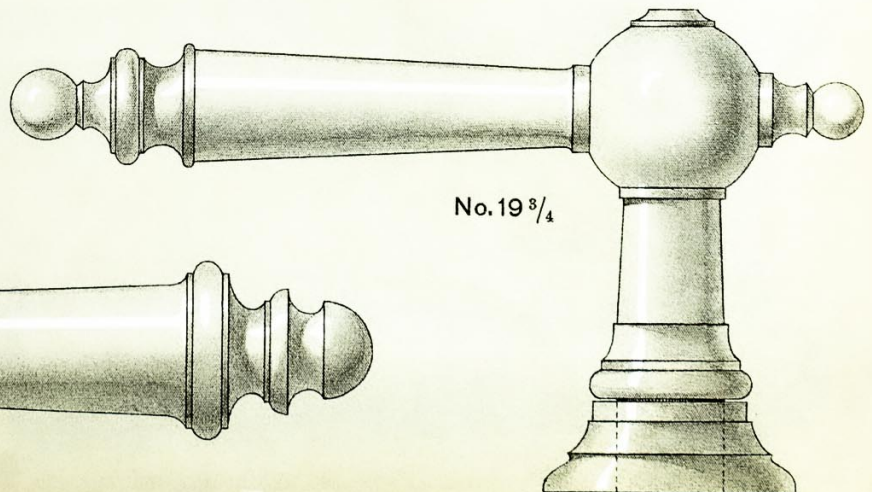

No. 19 3/4

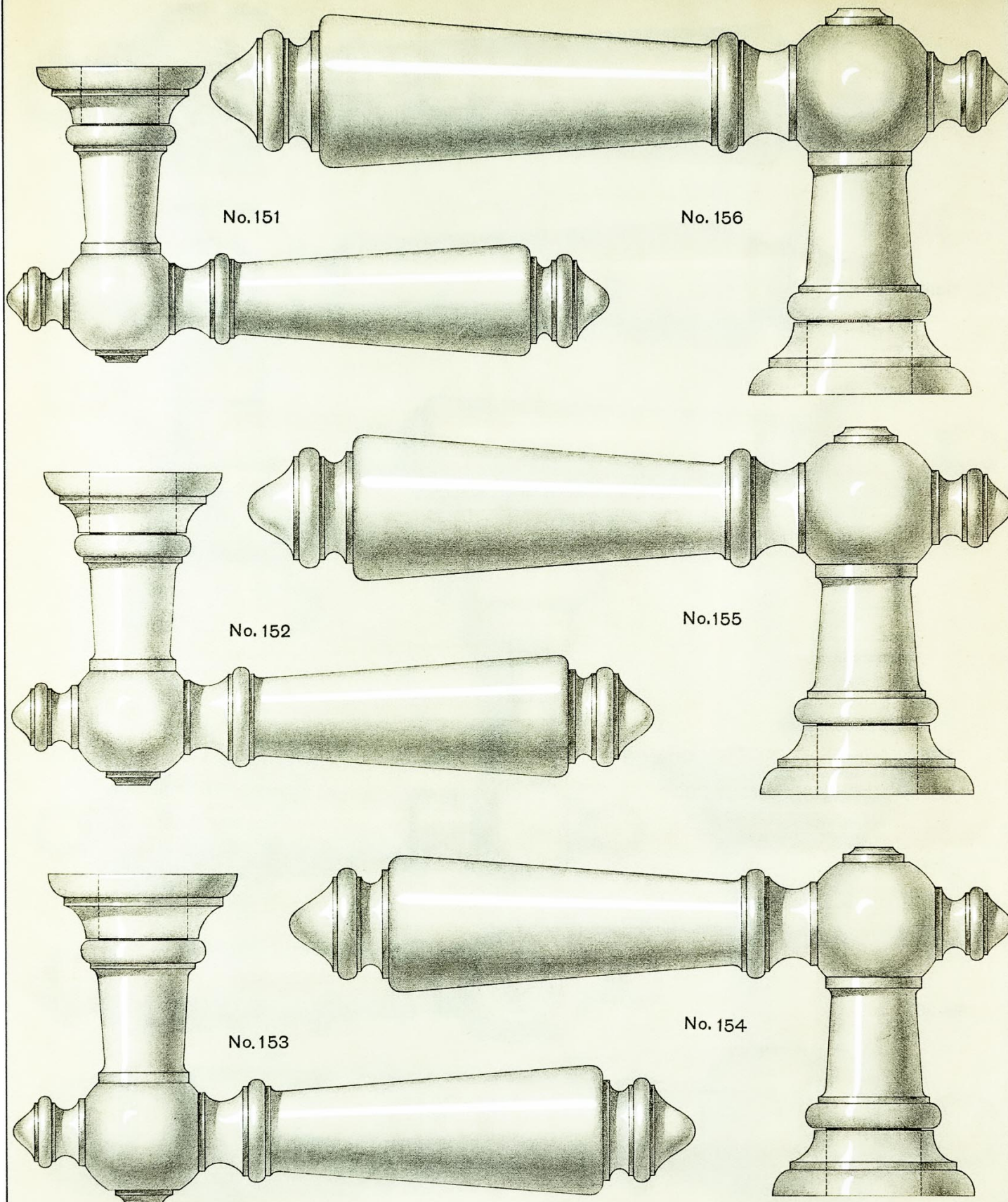

No.151

No. 156

No. 152

No.155

No.153

No. 154

Gesetzlich geschützt No. 151, 152, 153, 154, 155, 156 Déposés

No. 64 1/2

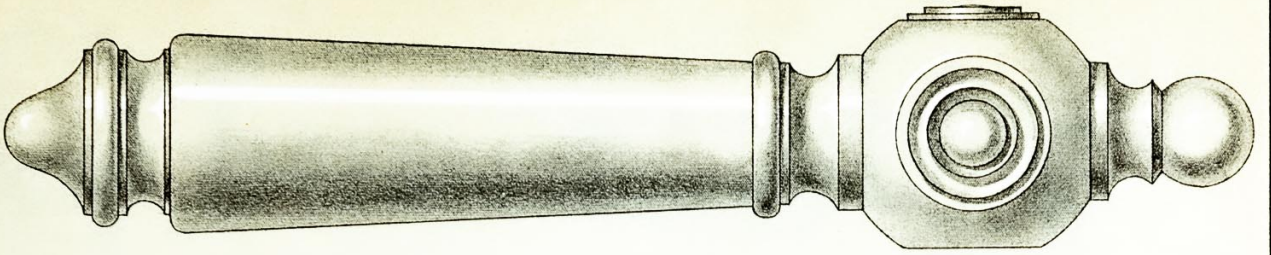

No. 64

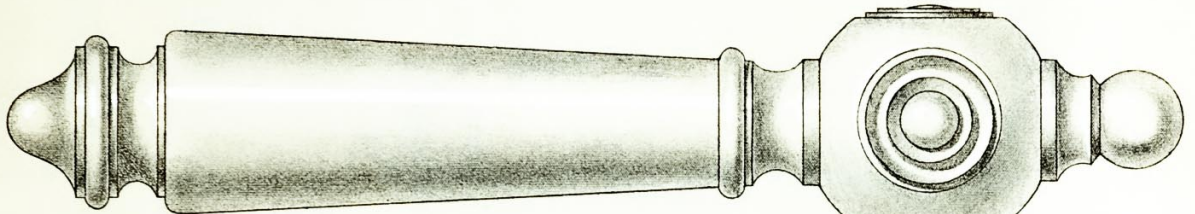

No. 49

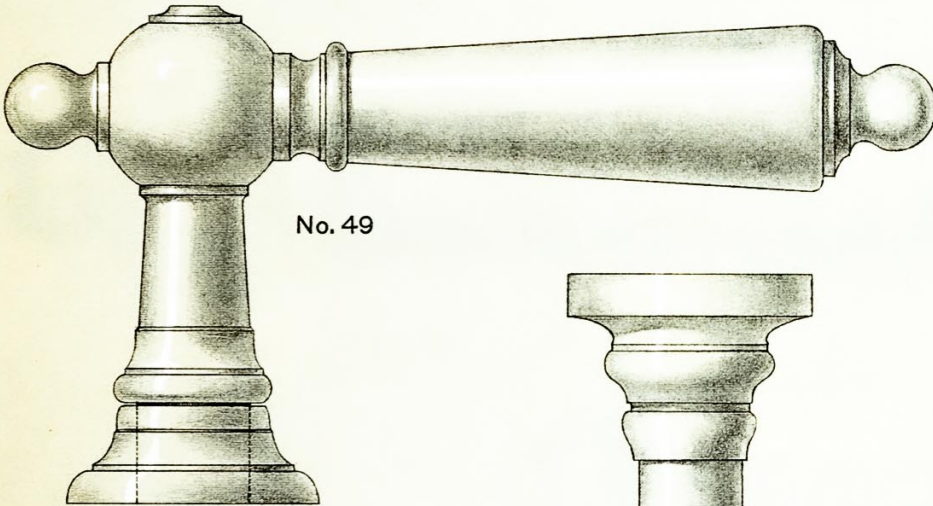

No. 48

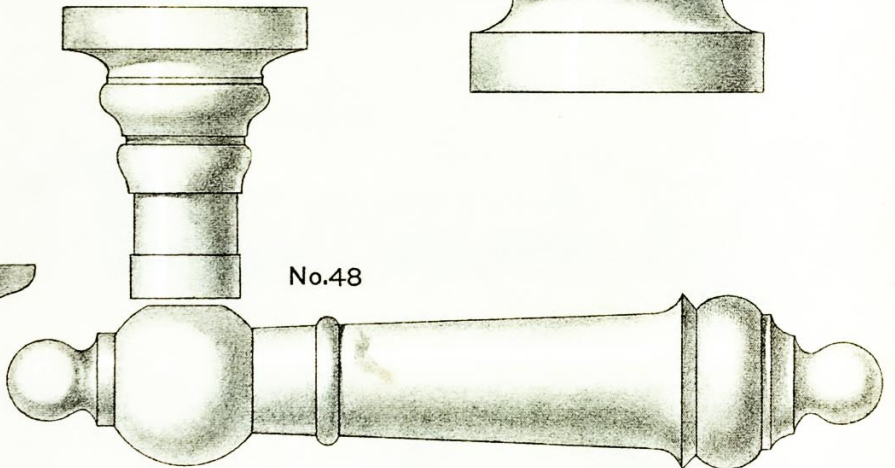

No. 30 1/2

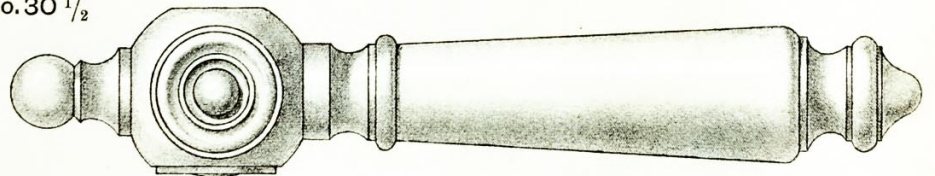

No. 36

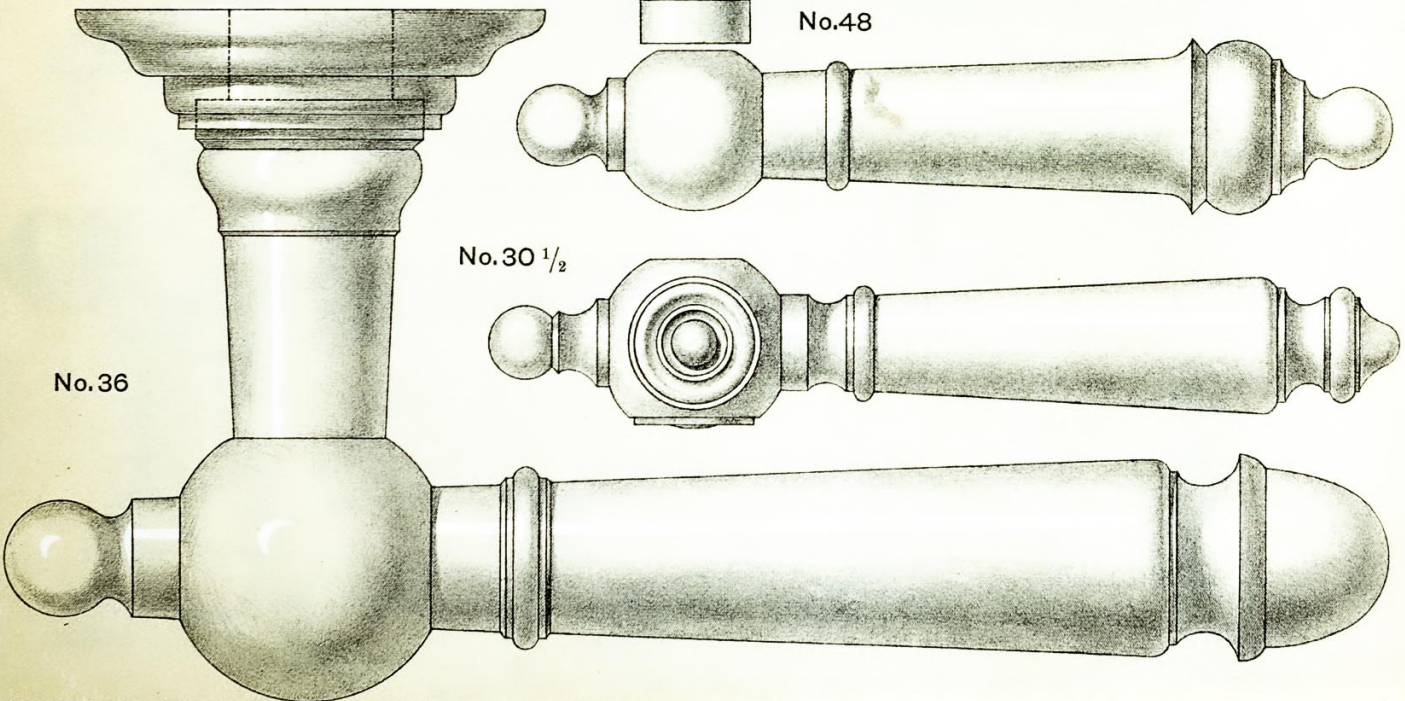

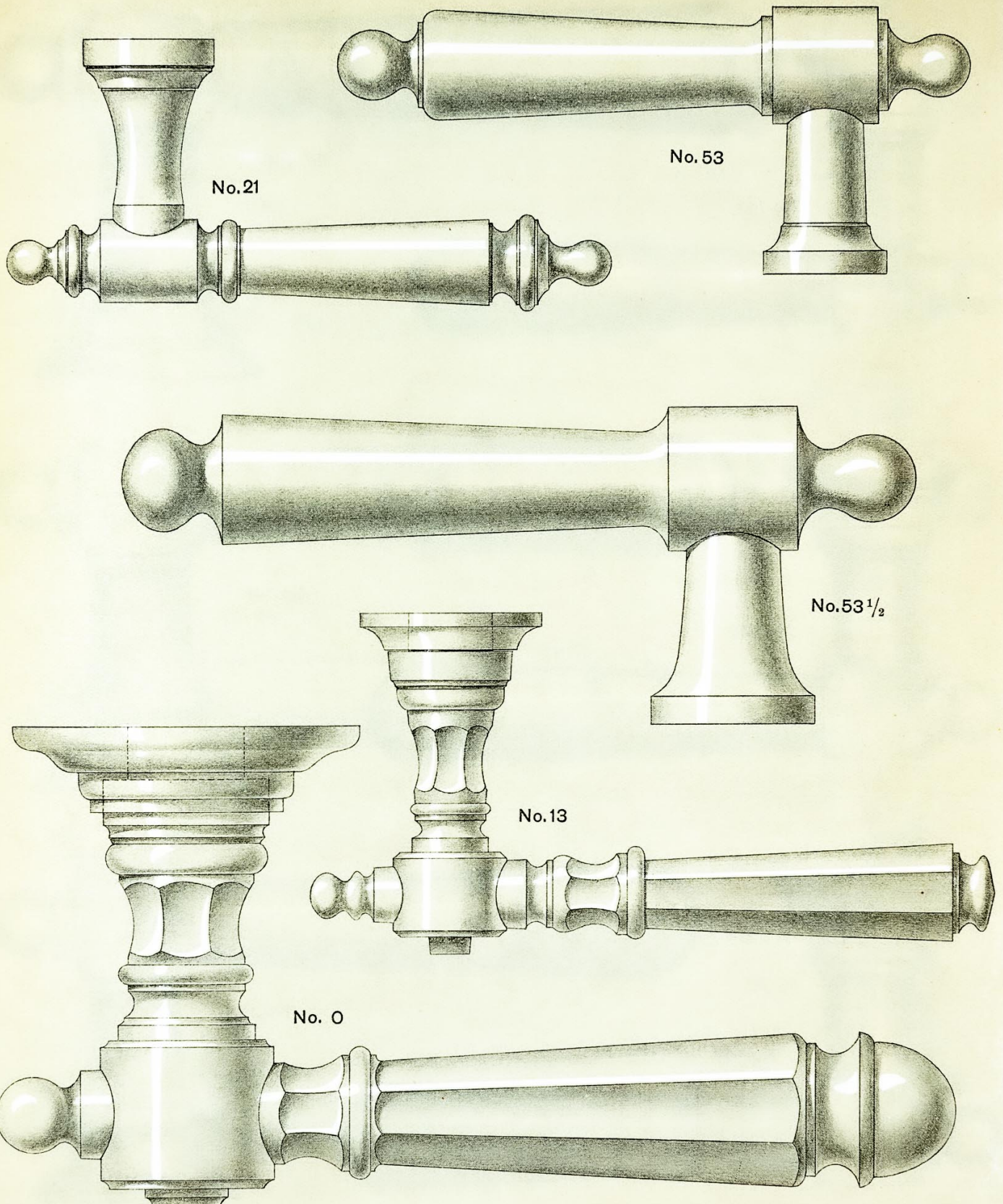

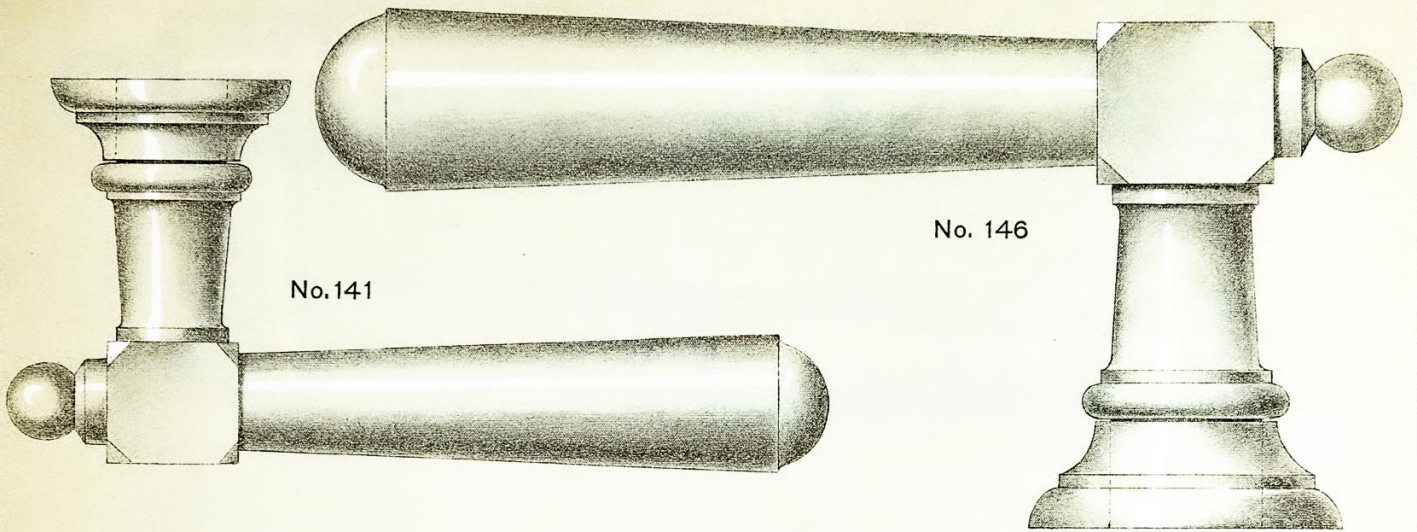

No.141

No. 146

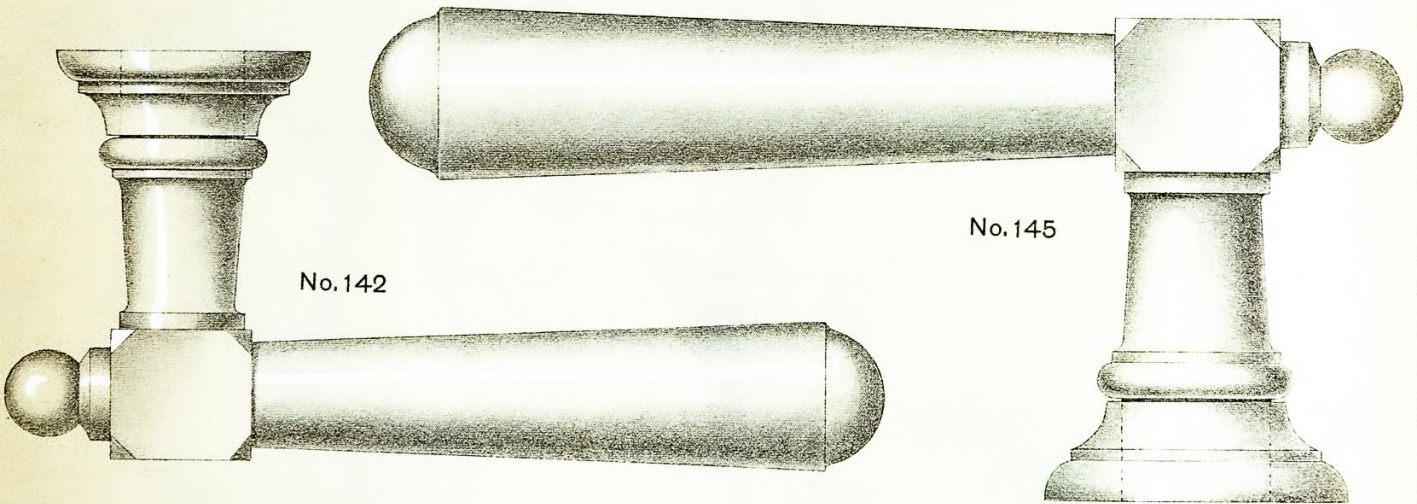

No.142

No.145

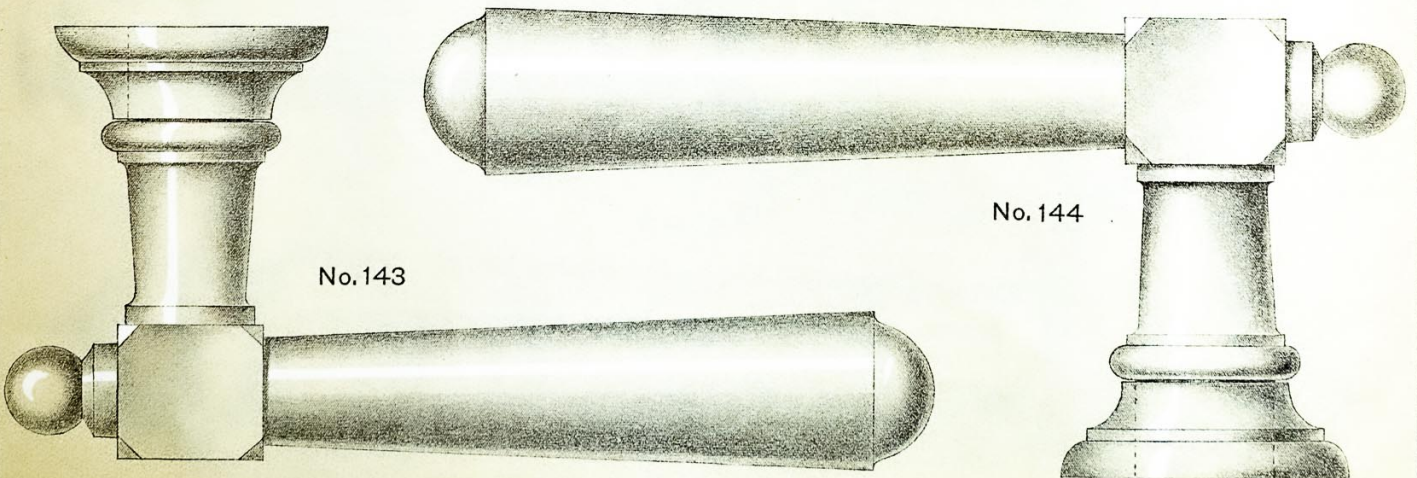

No.143

No.144

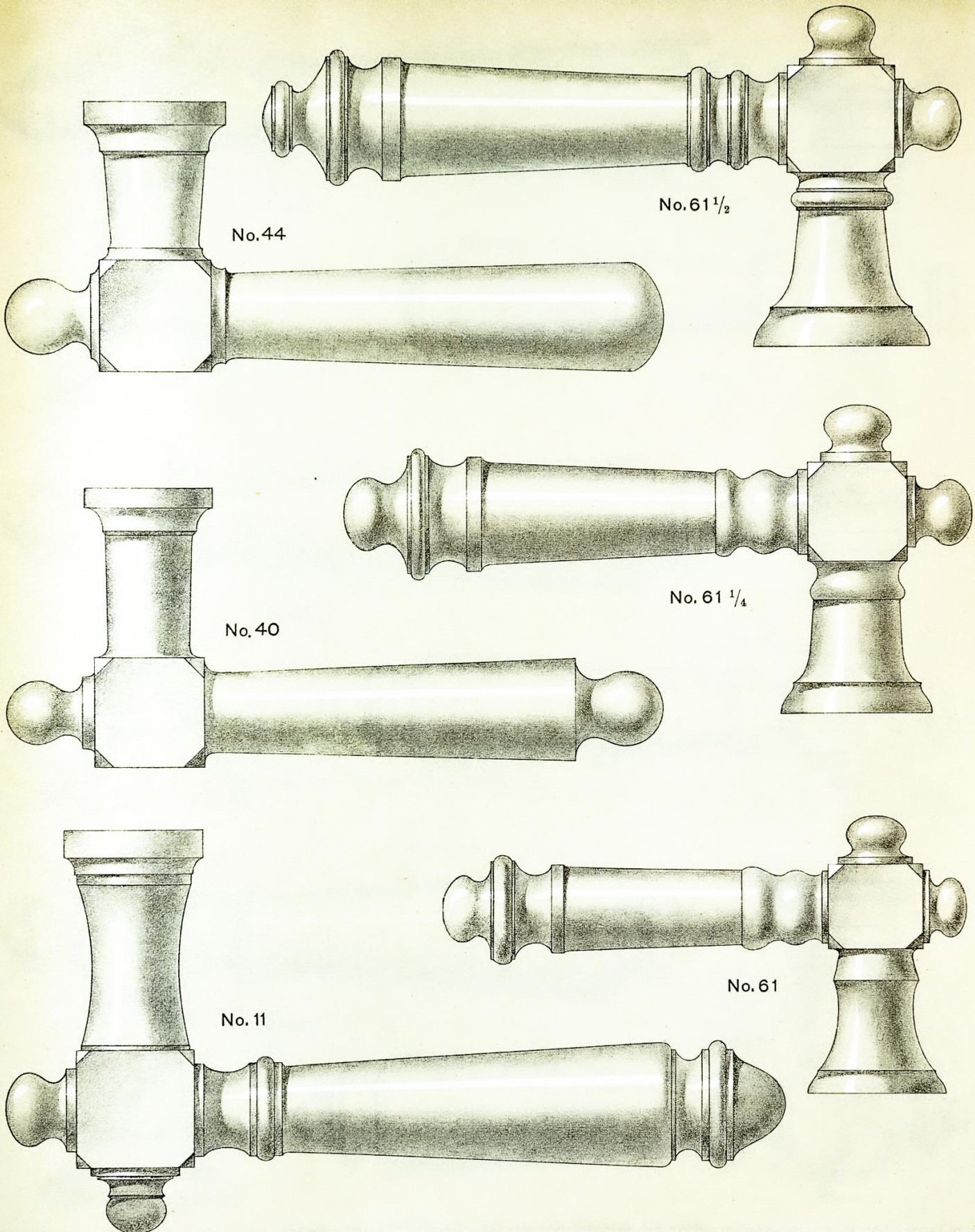

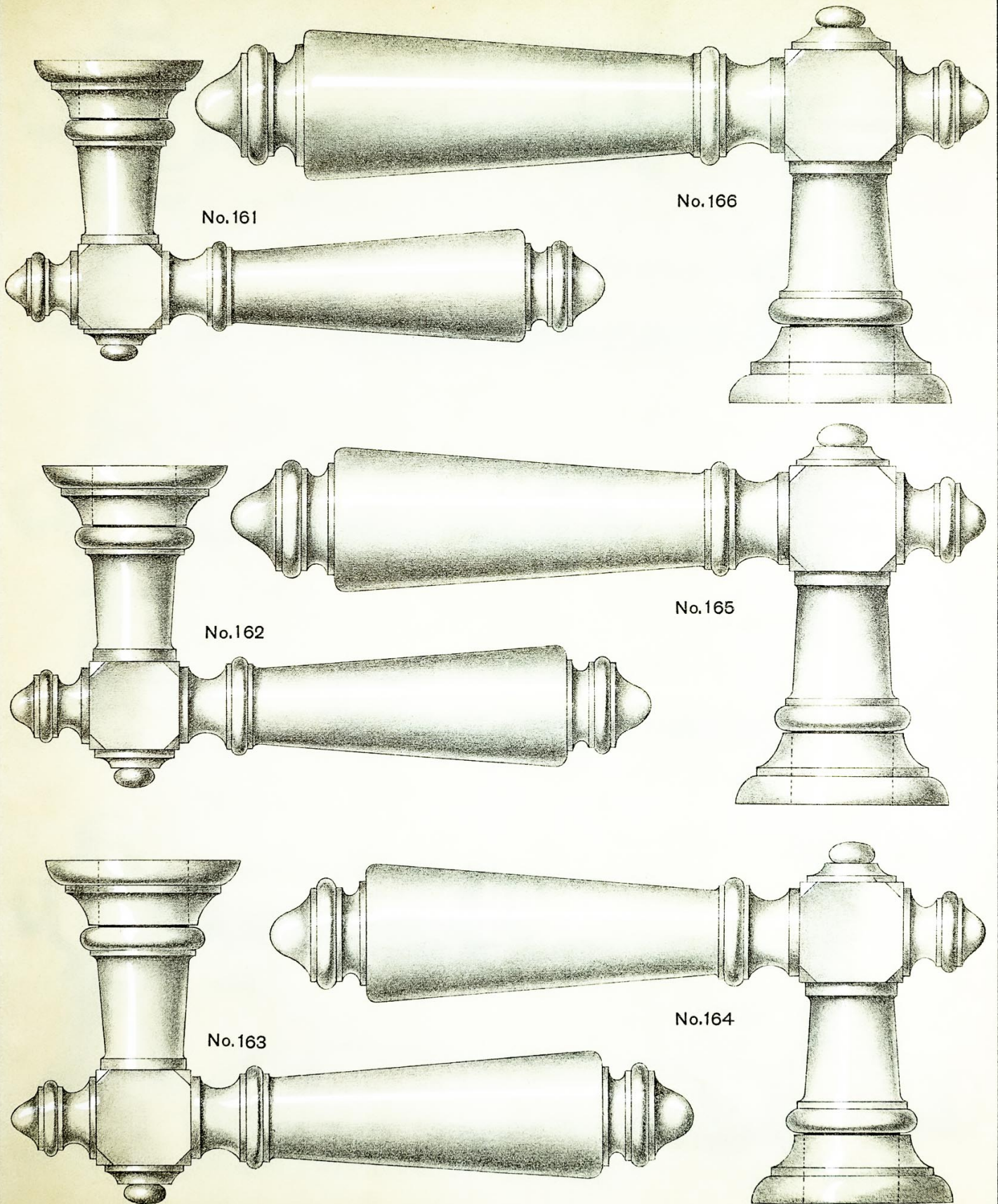

Gesetzlich geschützt No. 161, 162, 163, 164, 165, 166 Déposés



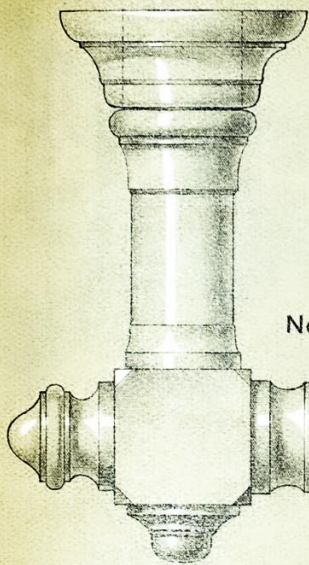

No. 51

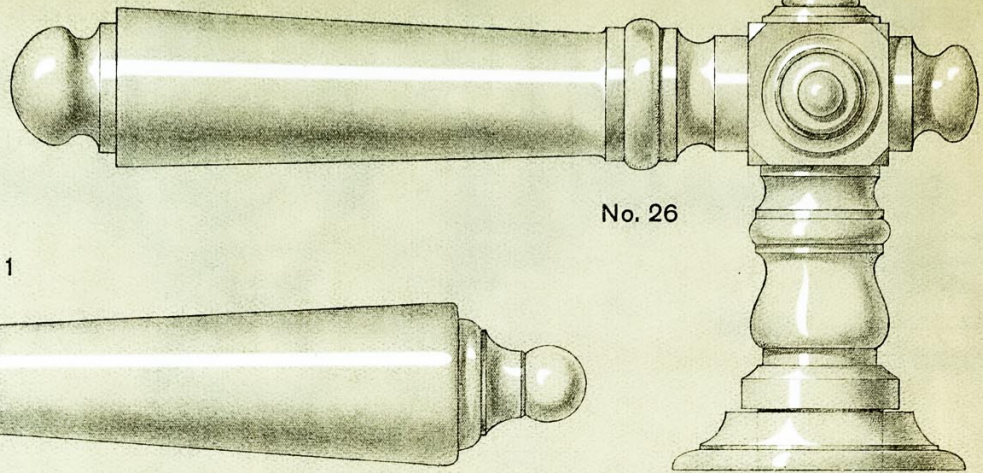

No. 26

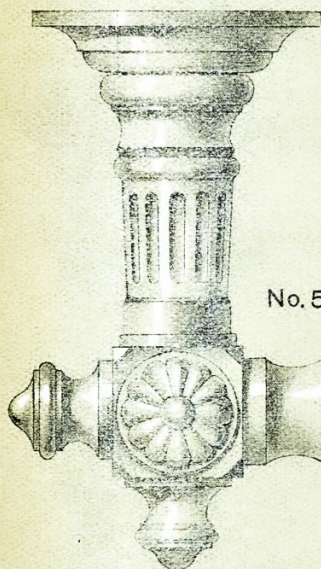

No. 52

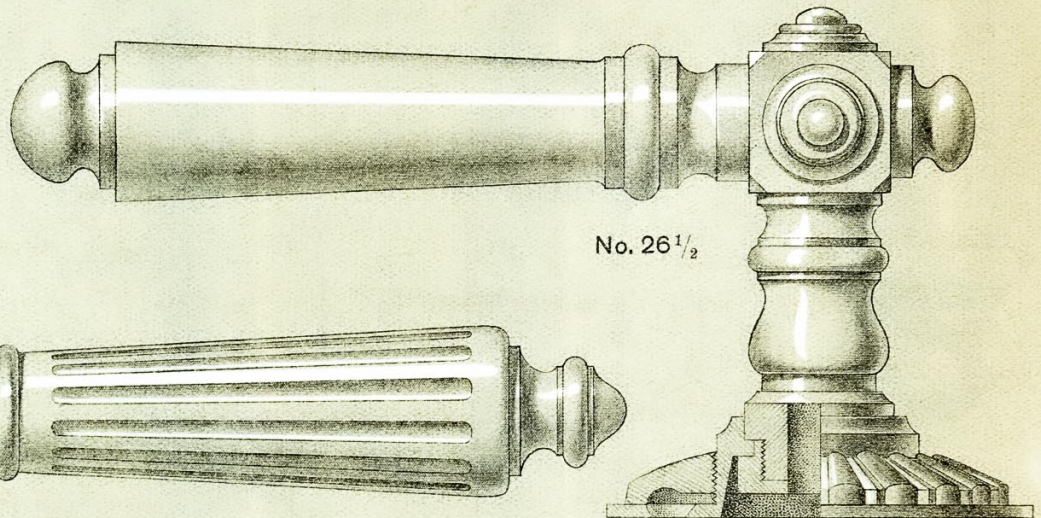

No. 26 1/2

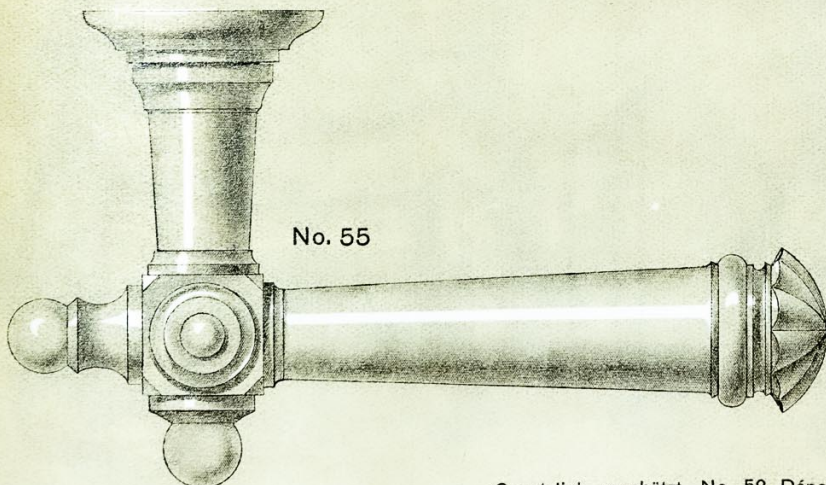

No. 55

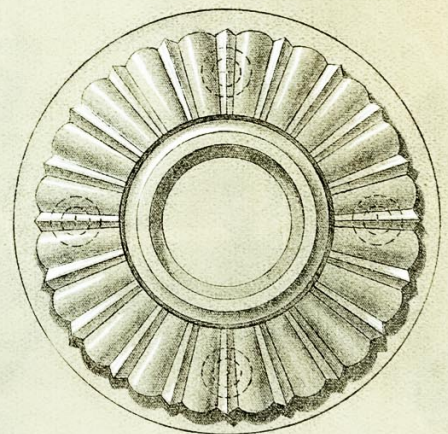

Gesetzlich geschützt No. 52 Déposé



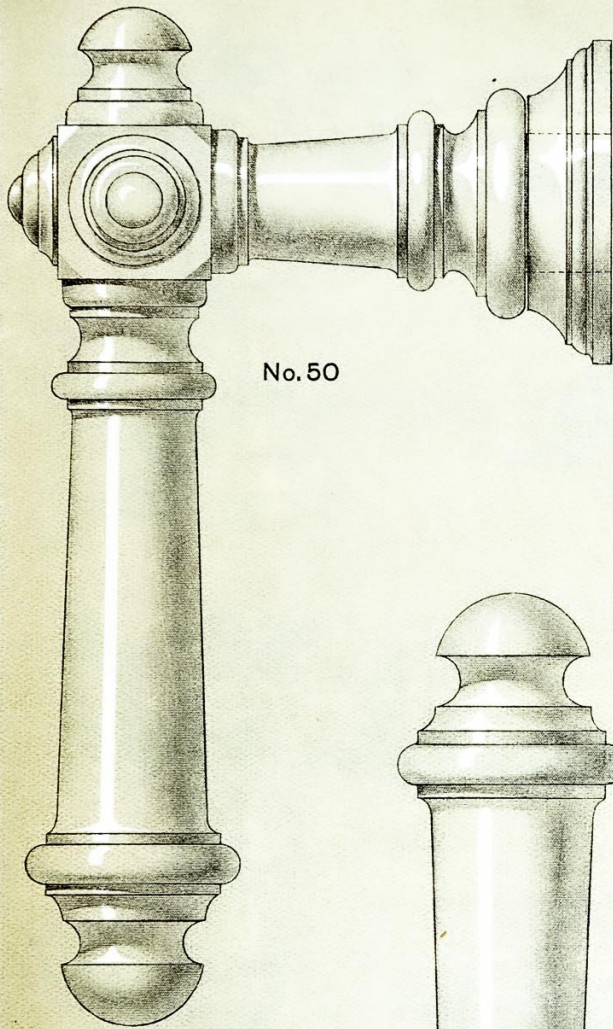

No. 50

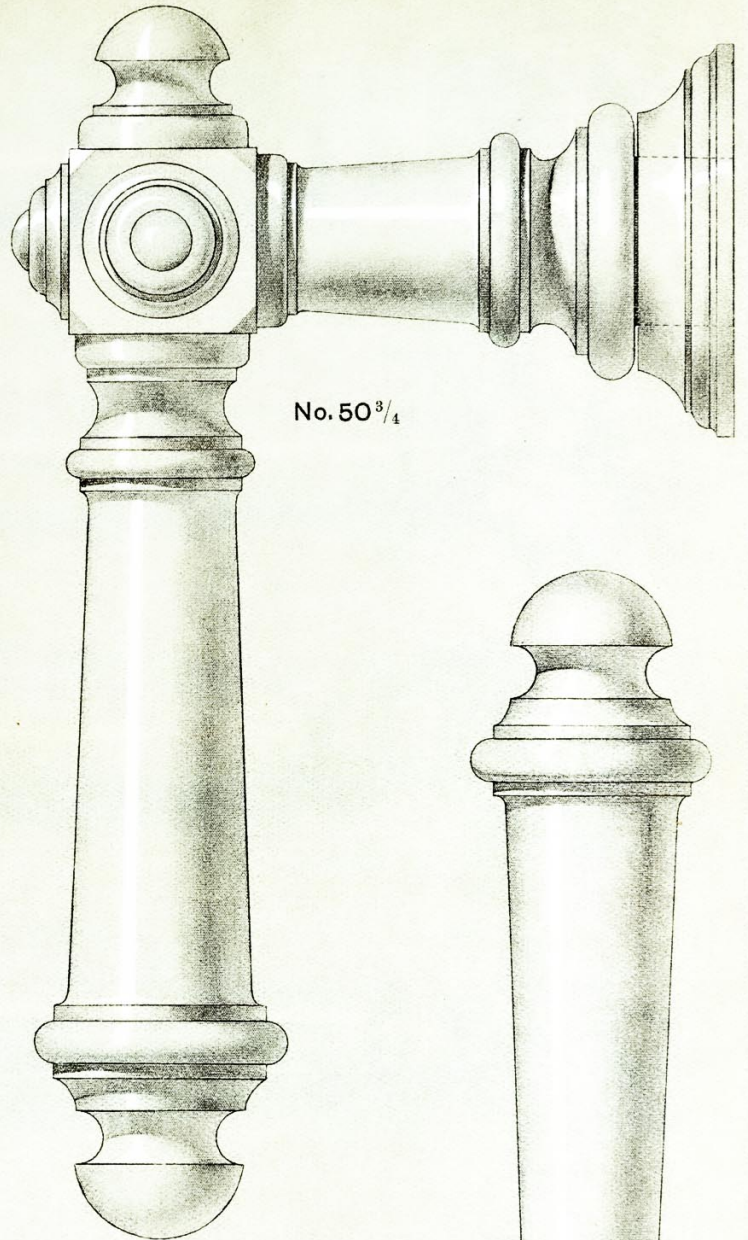

No. 50^{3/4}

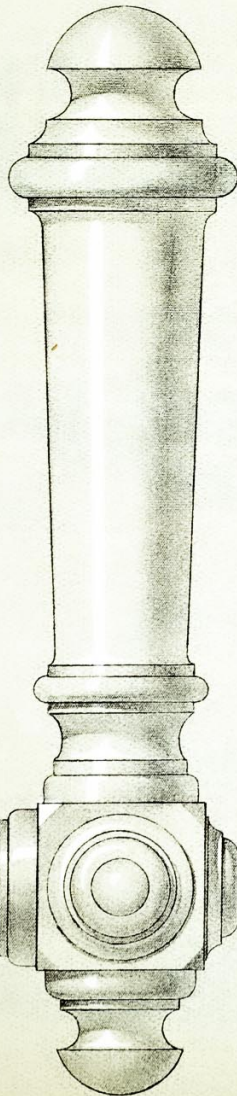

No. 50^{1/4}

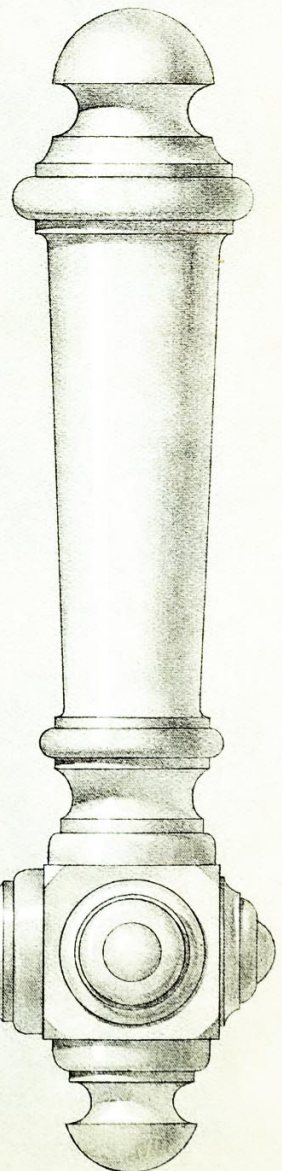

No. 50^{1/2}

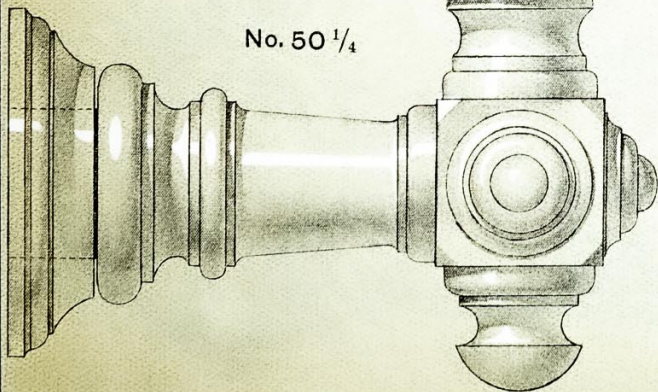

Gesetzlich geschützt No. 50, 50^{1/4}, 50^{1/2}, 50^{3/4} Déposés



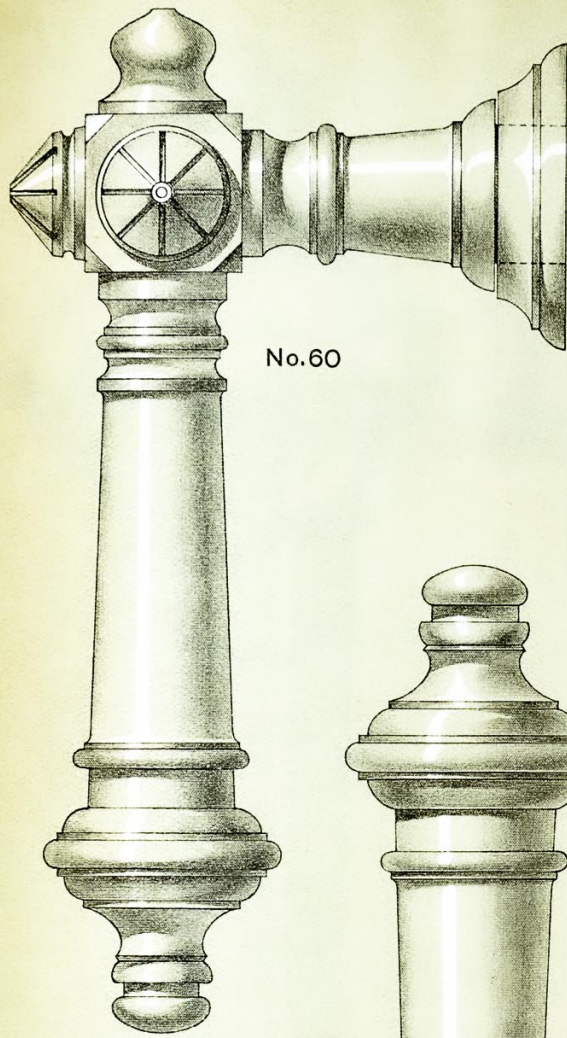

No. 60

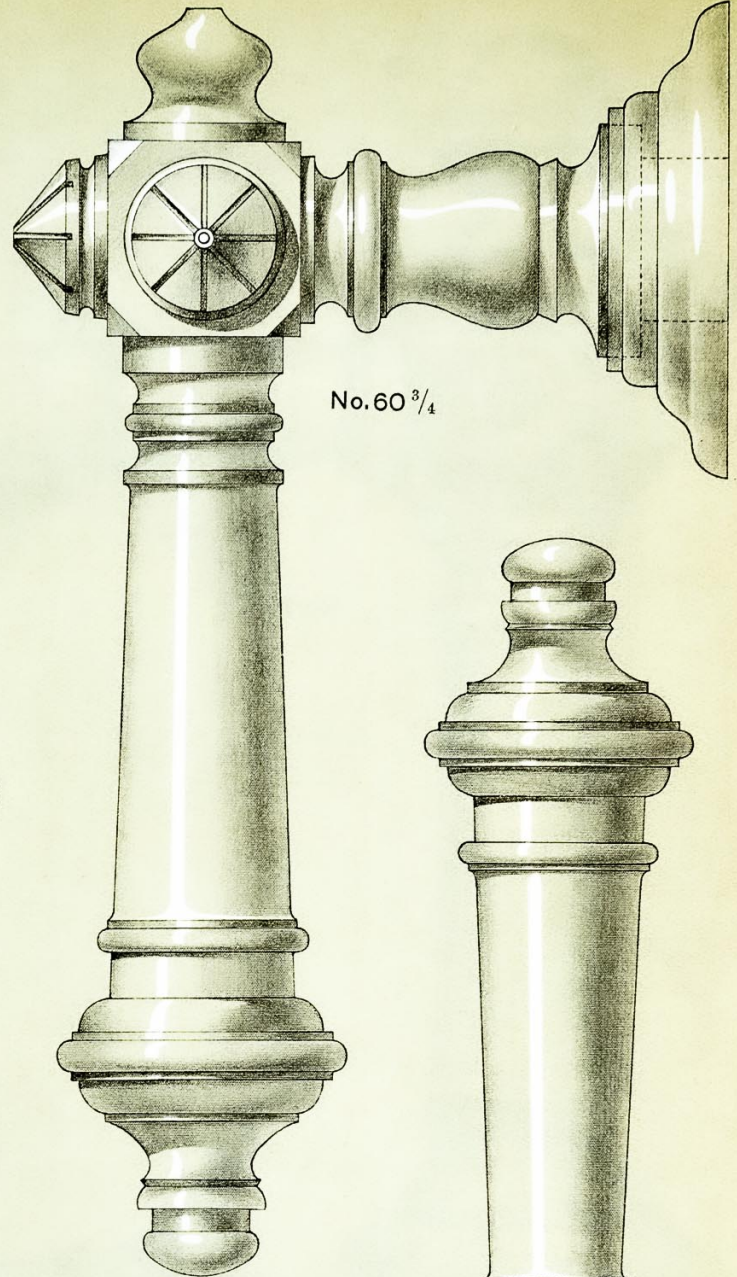

No. 60 ³/₄

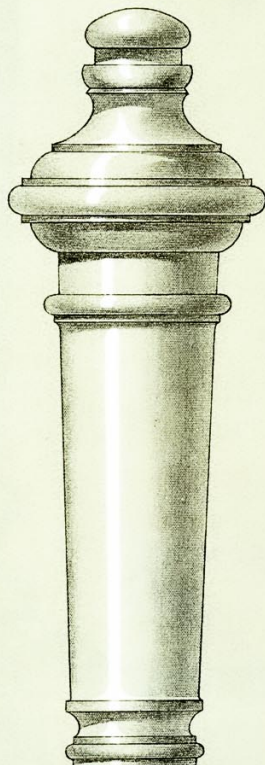

No. 60 ¹/₄

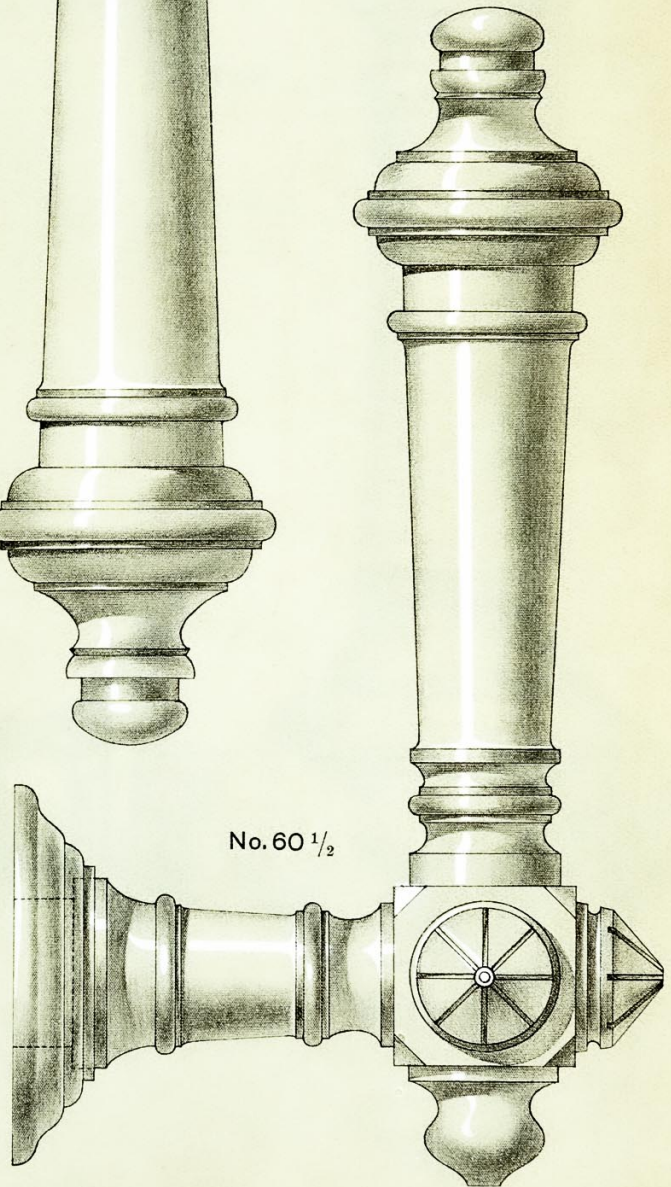
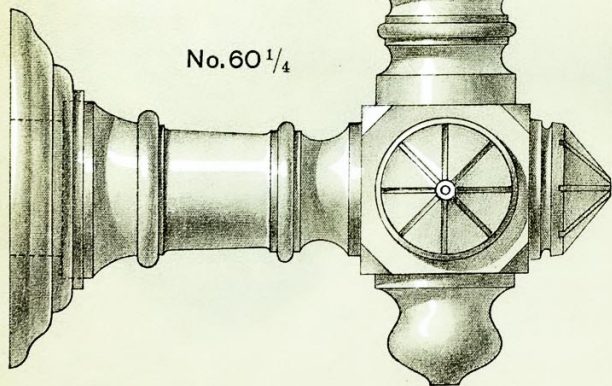

No. 60 ¹/₂

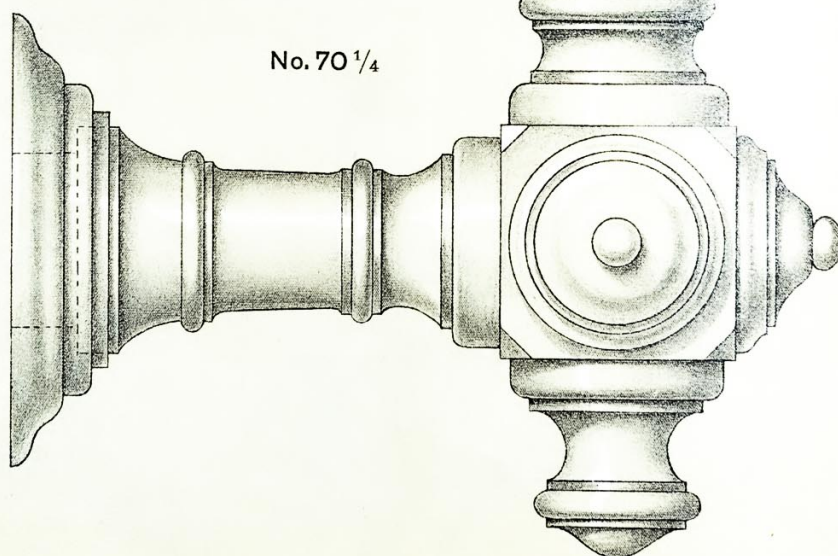
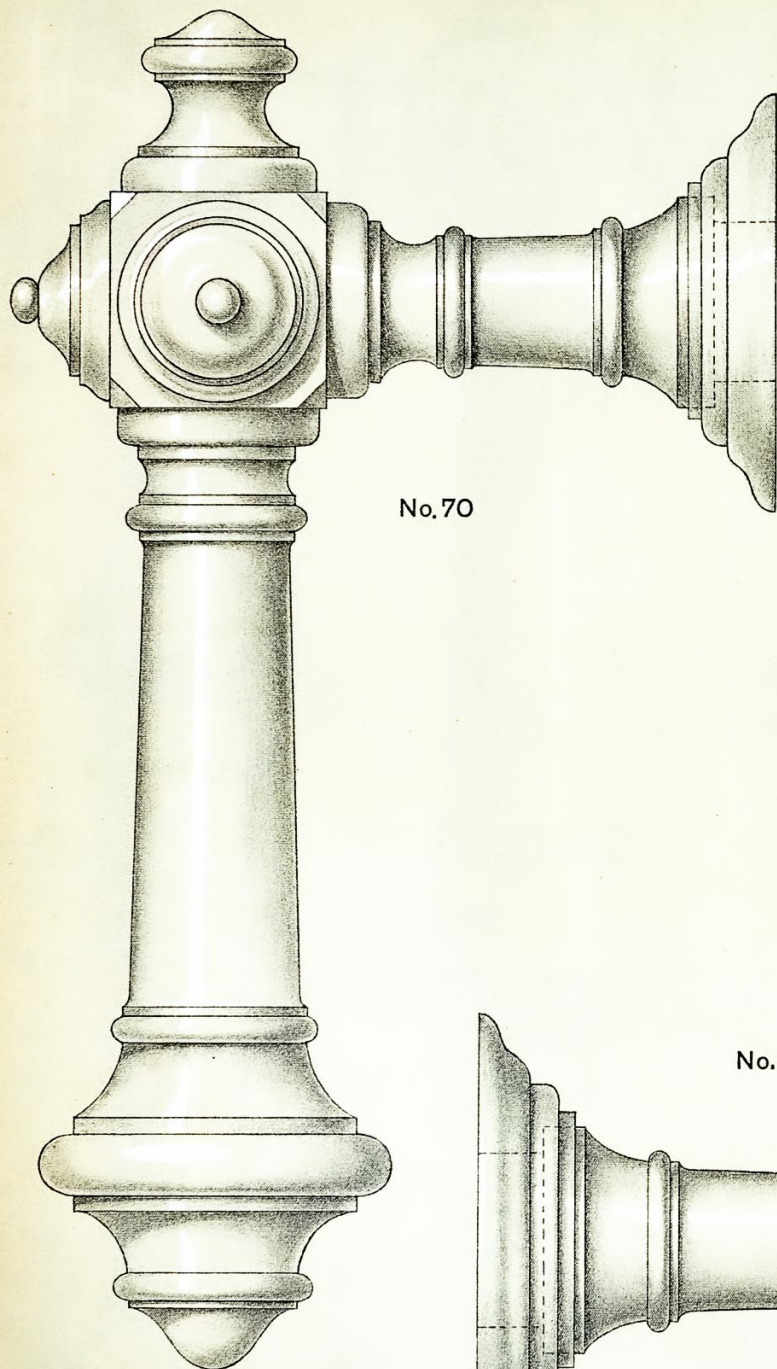

Gesetzlich geschützt No. 70, 70 1/4, Déposés



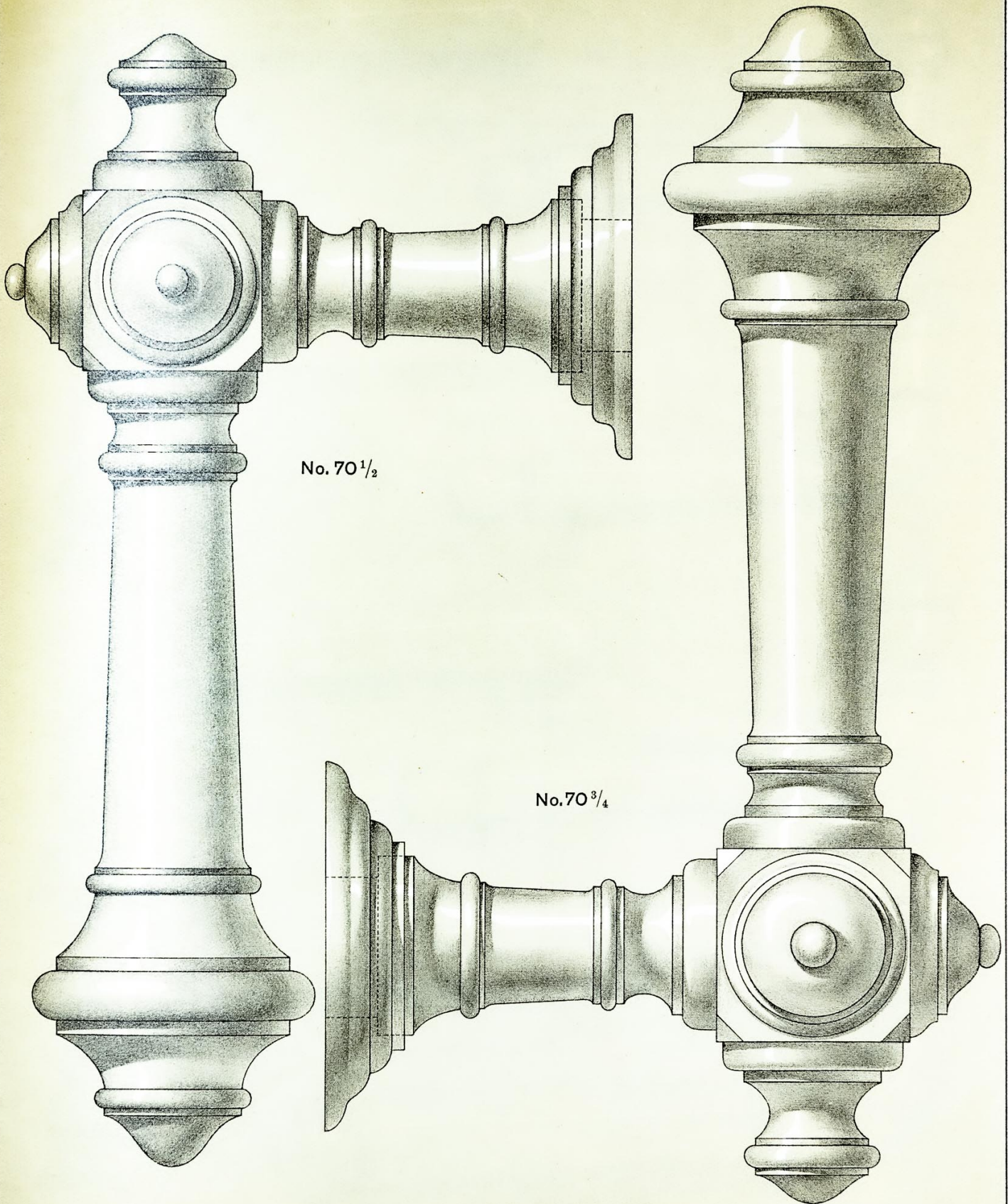

No. 70^{1/2}

No. 70^{3/4}

Gesetzlich geschützt No. 70^{1/2}, 70^{3/4} Déposés



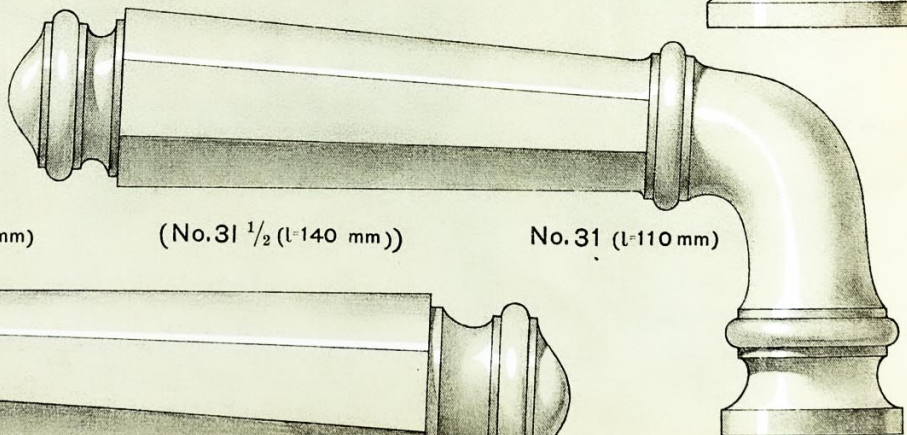
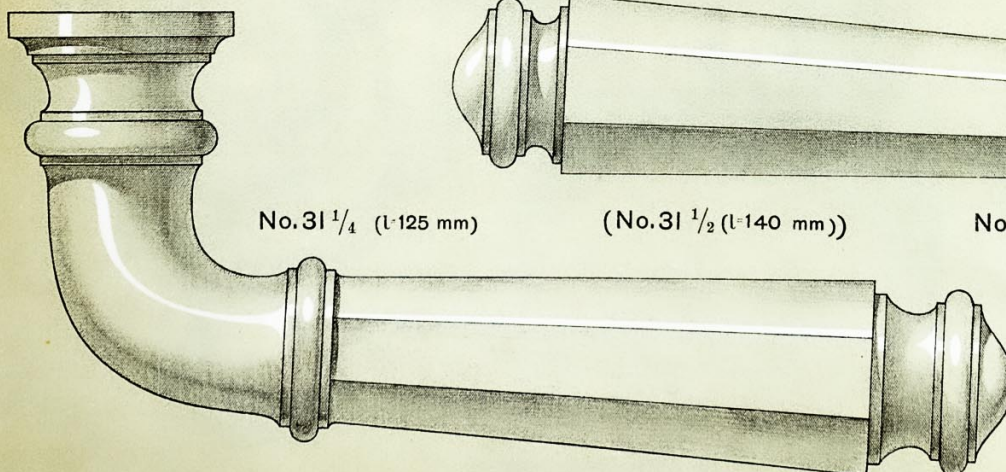
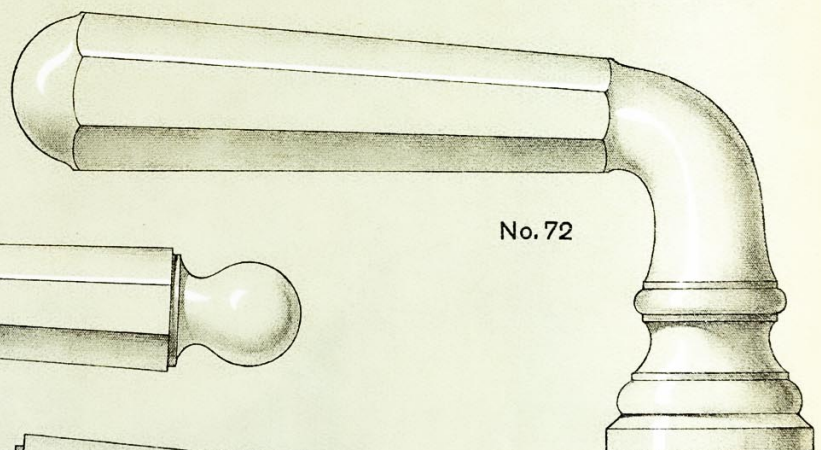
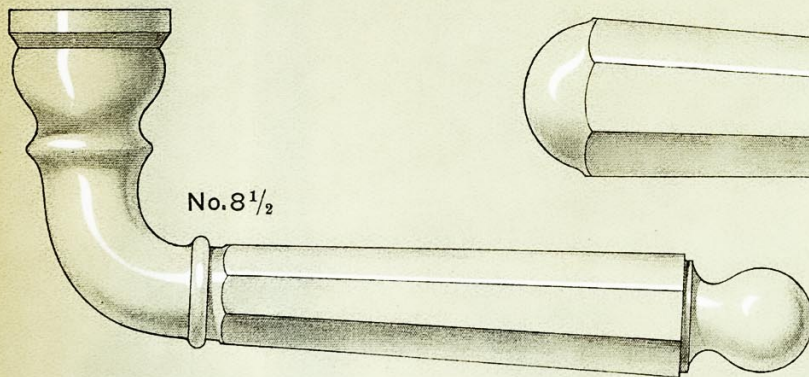
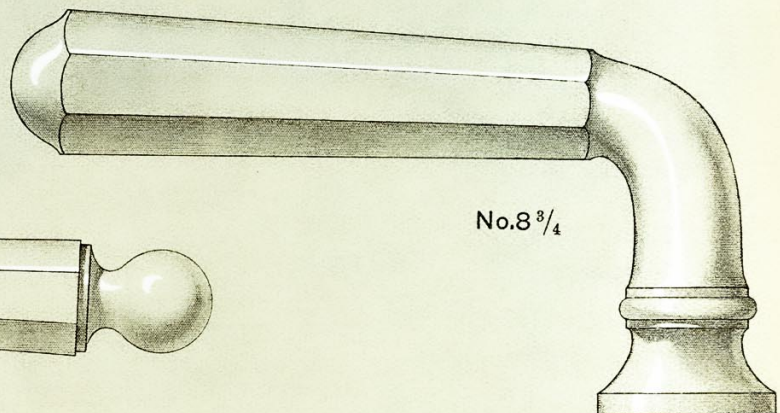
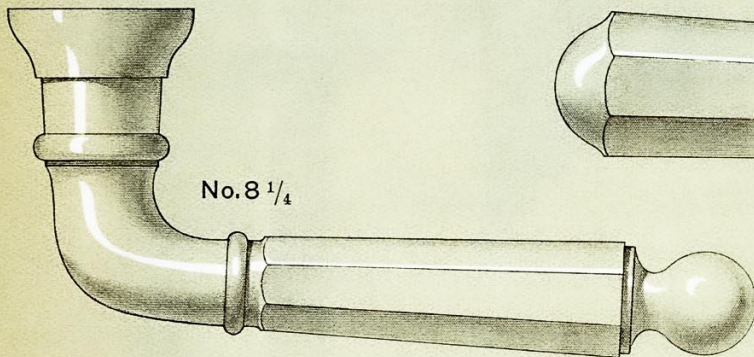
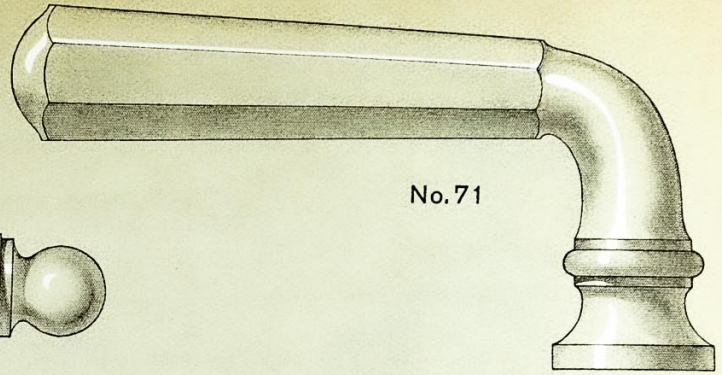
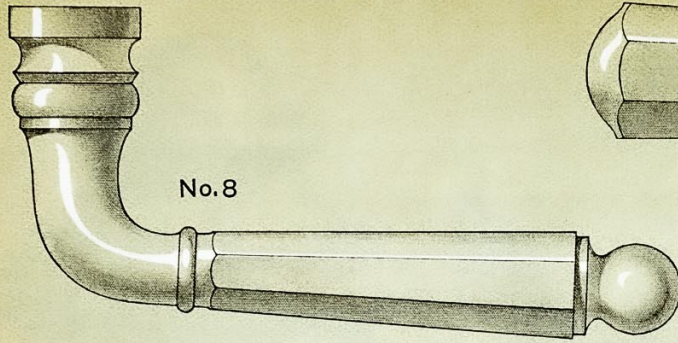

No. 31 (l-110 mm)

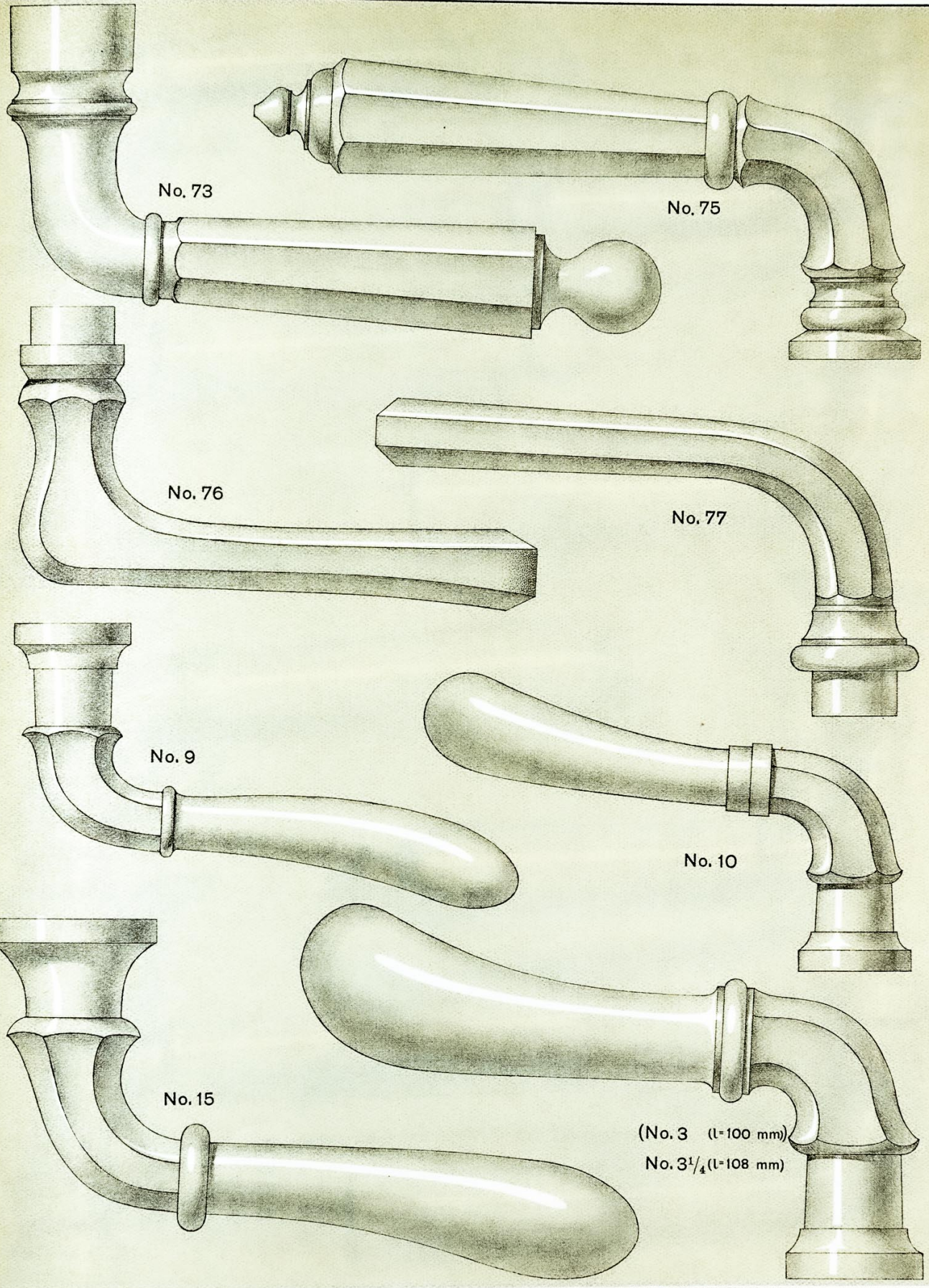

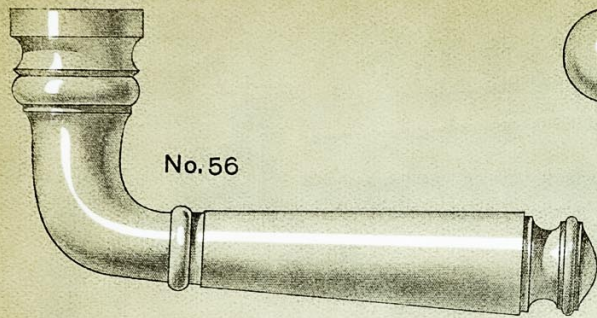

No. 56

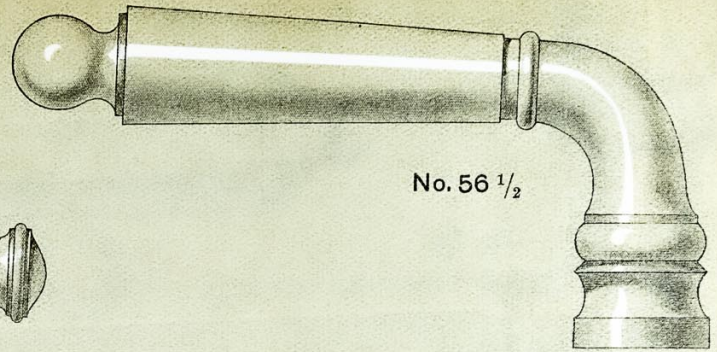

No. 56 1/2

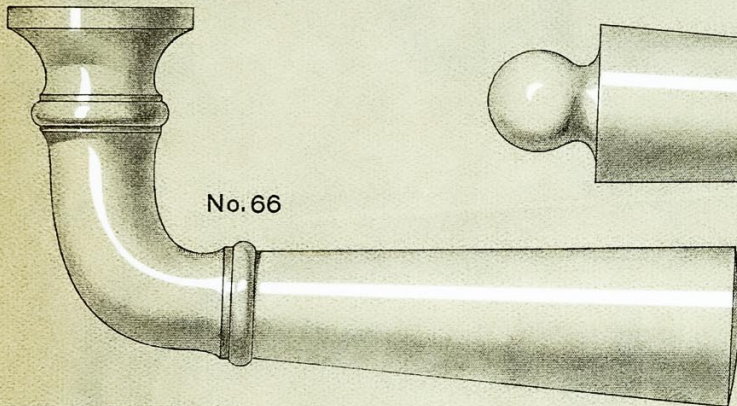

No. 66

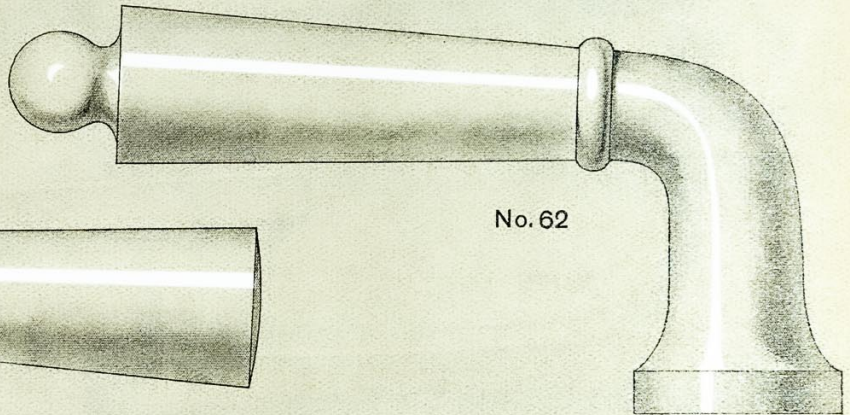

No. 62

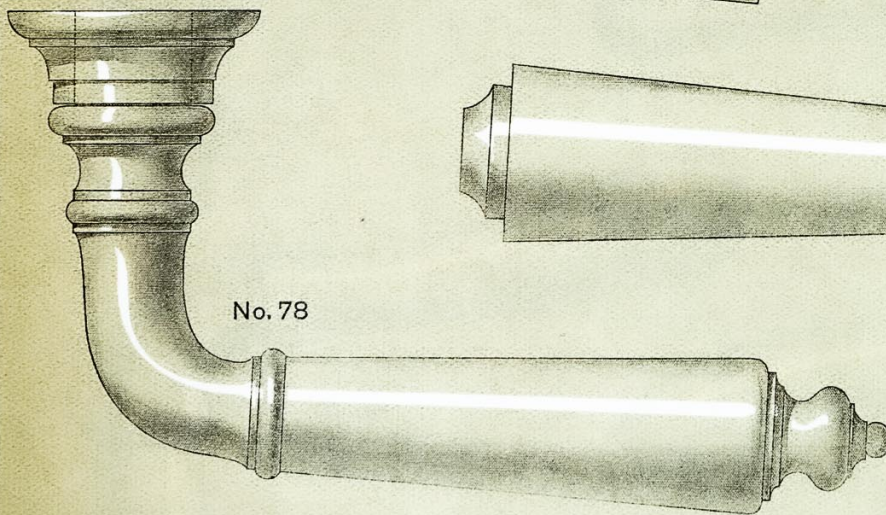

No. 78

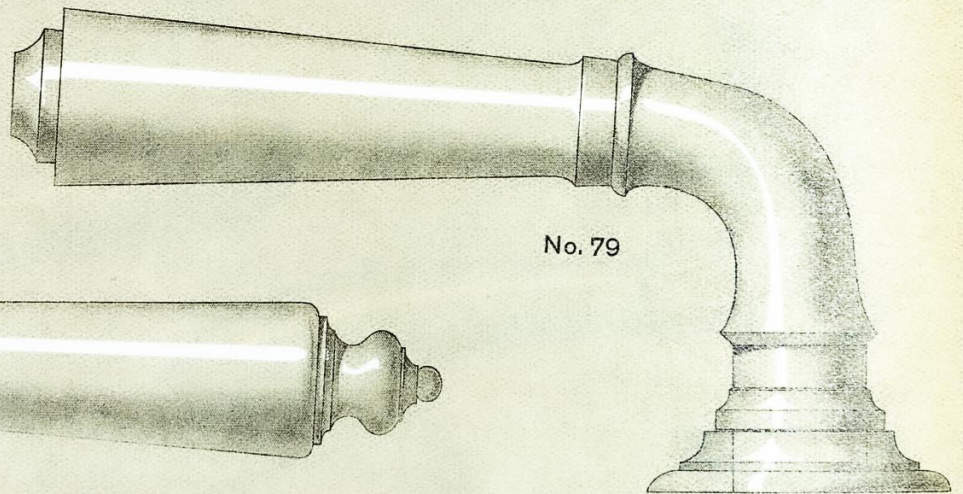

No. 79

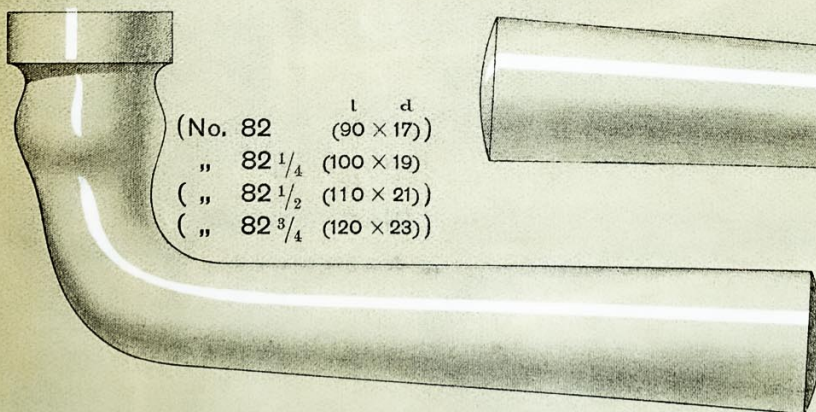

(No. 82	l	d
	(90 × 17)	
" 82 1/4	(100 × 19)	
(" 82 1/2	(110 × 21)	
(" 82 3/4	(120 × 23)	

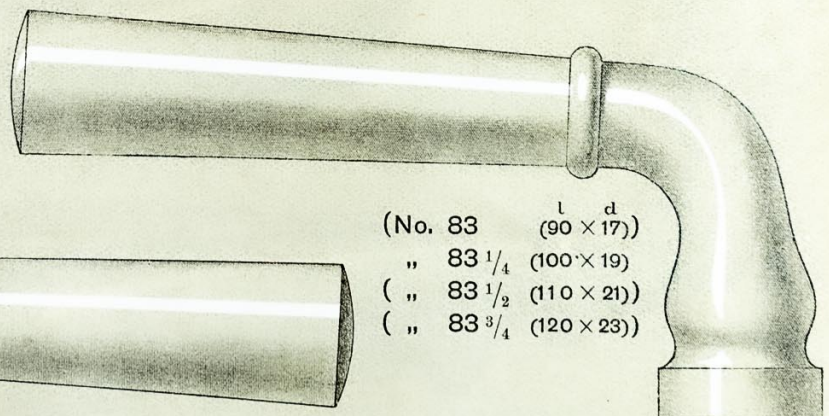

(No. 83	l	d
	(90 × 17)	
" 83 1/4	(100 × 19)	
(" 83 1/2	(110 × 21)	
(" 83 3/4	(120 × 23)	



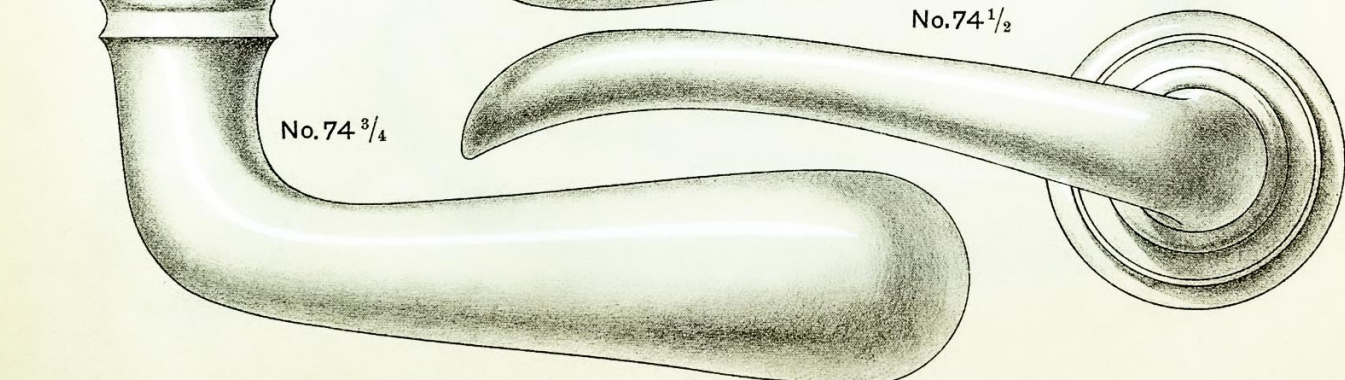
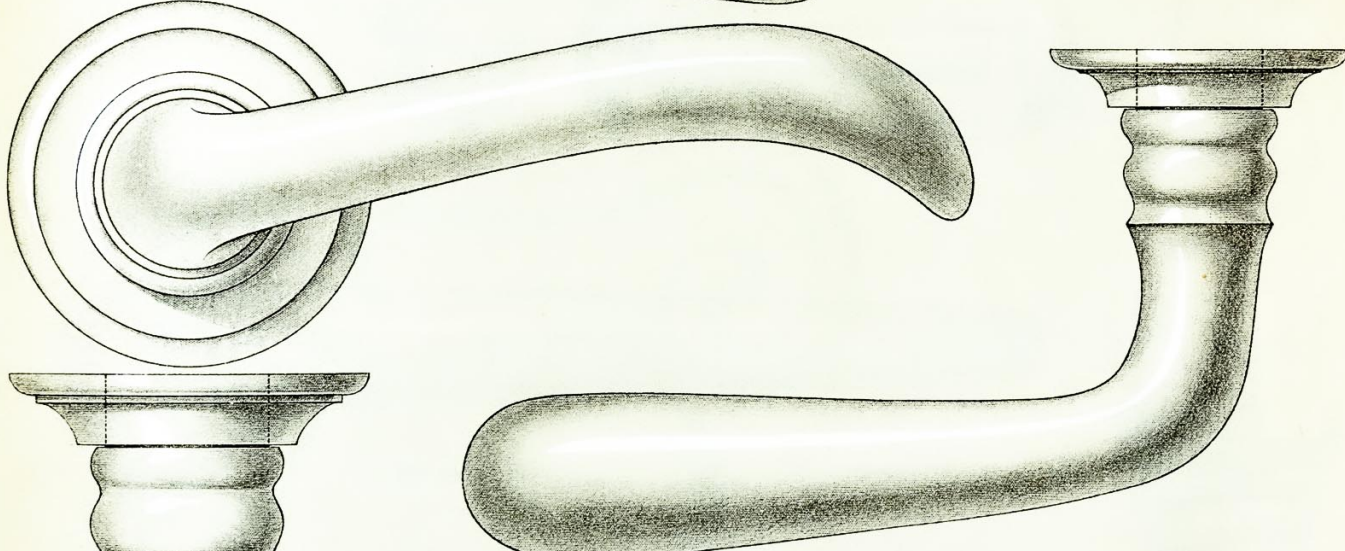
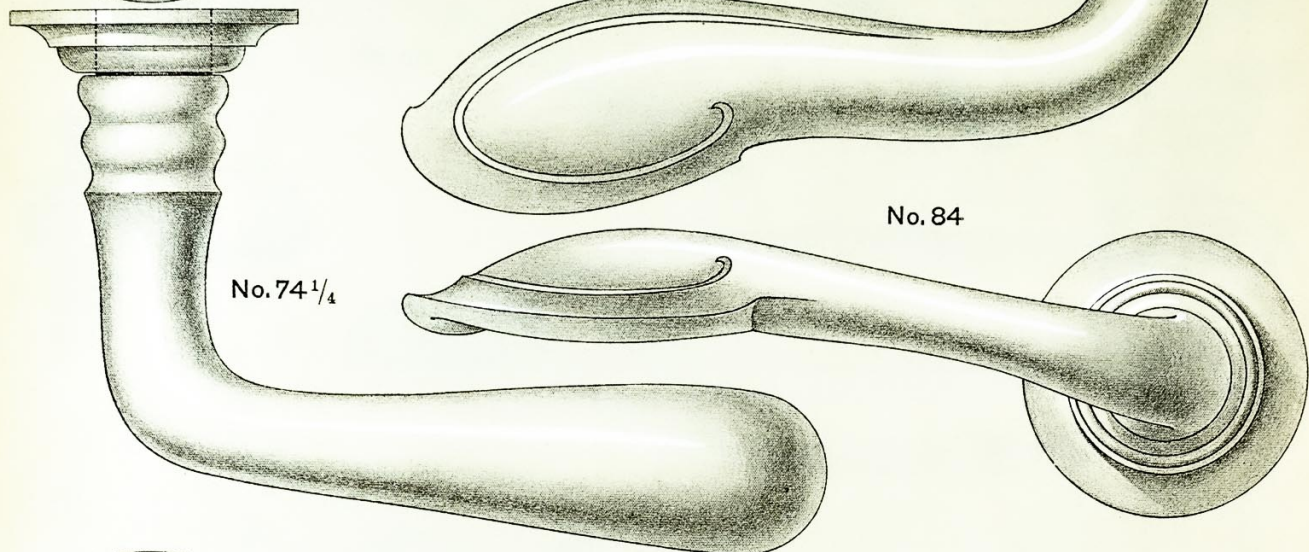
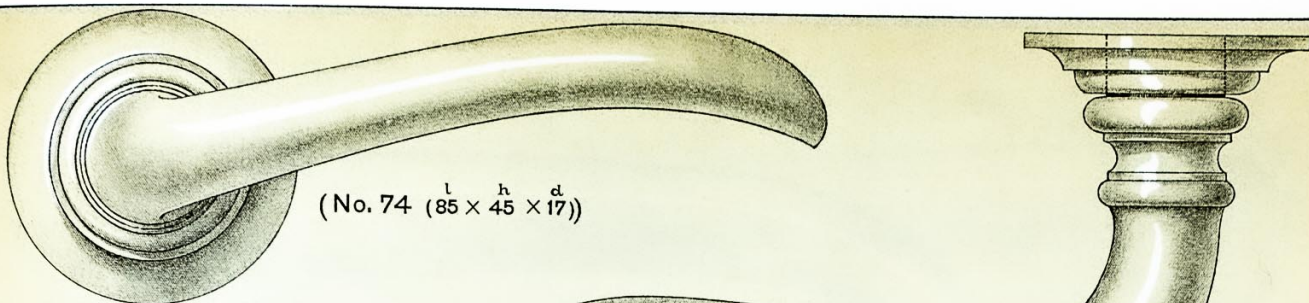

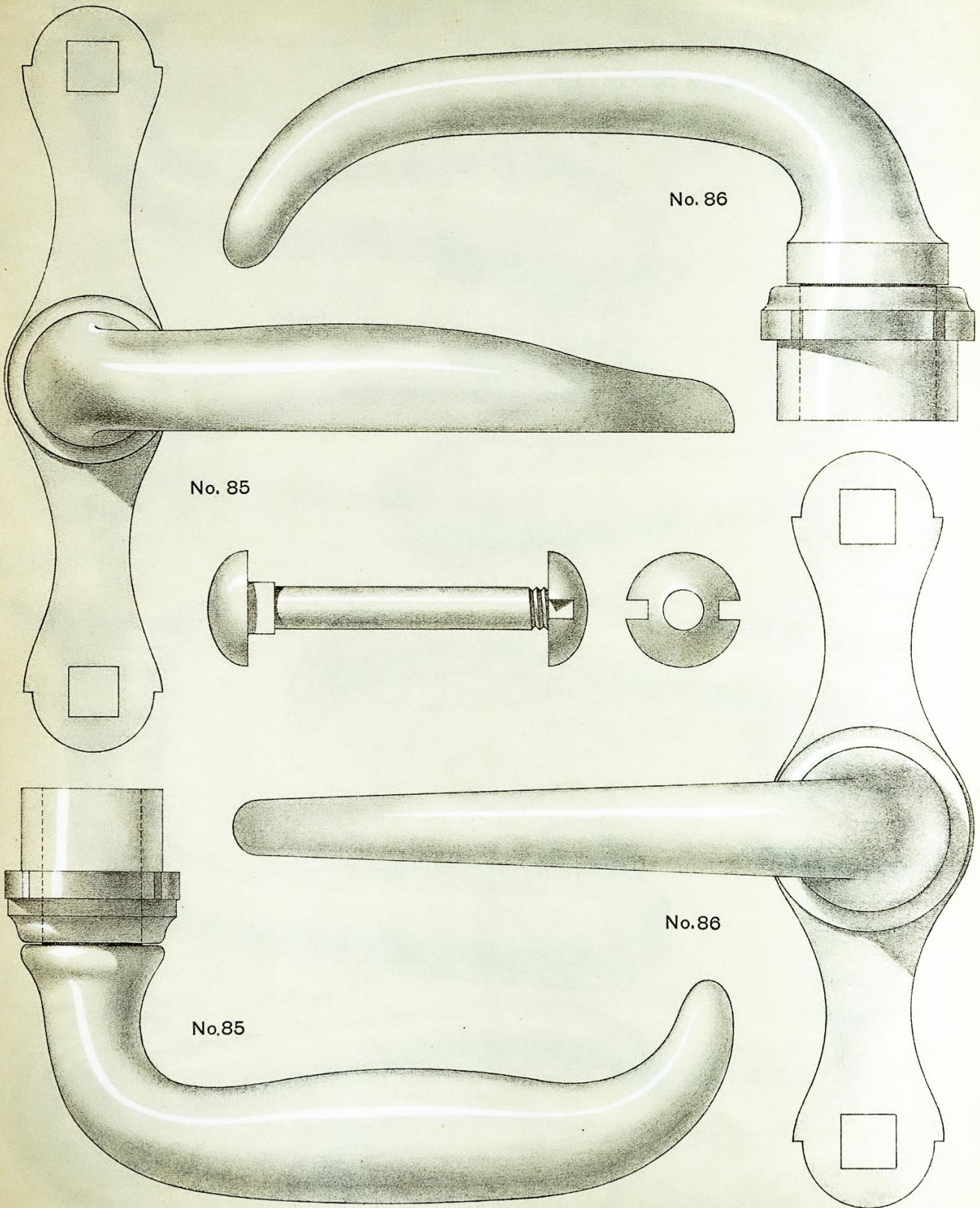

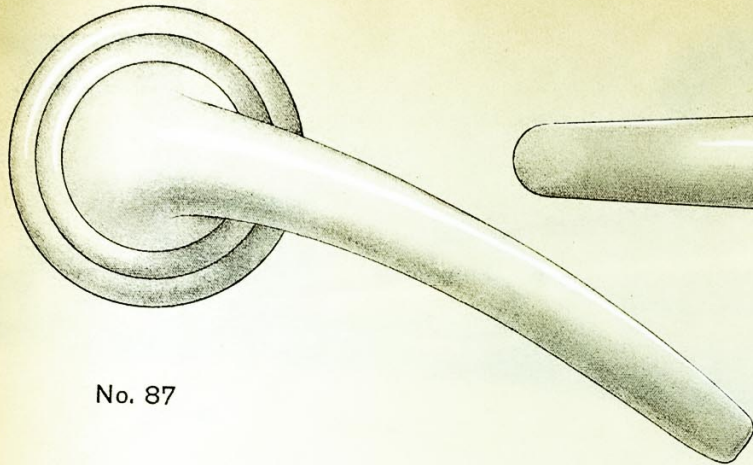

No. 87

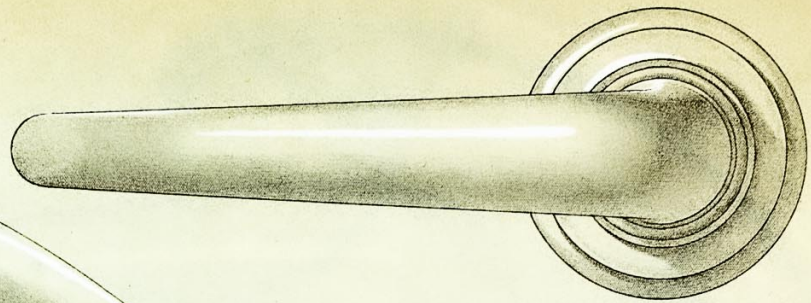

No. 88

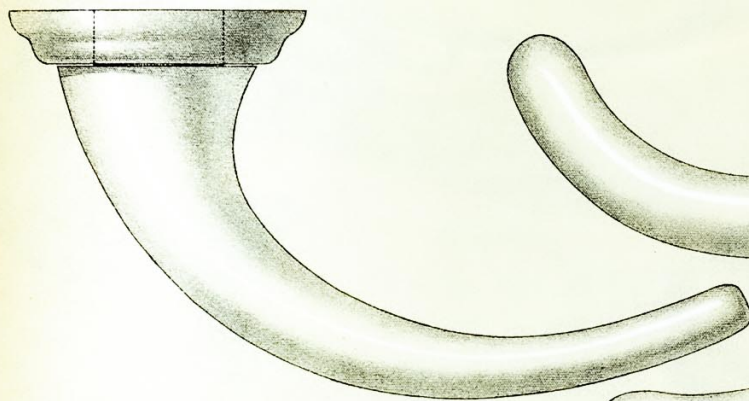

No. 89

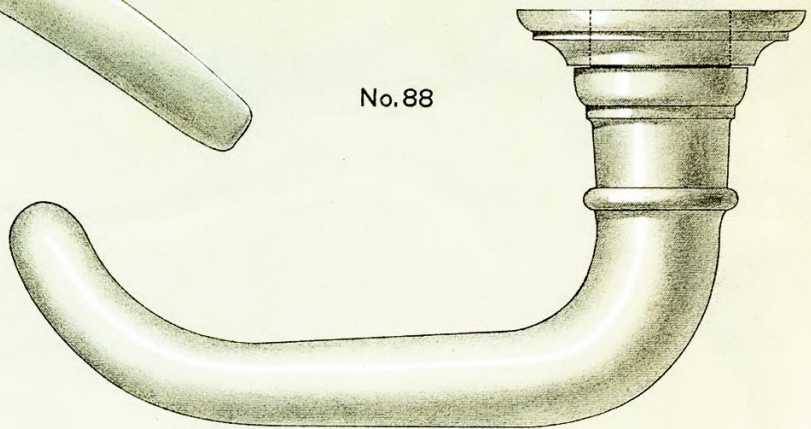

No. 90

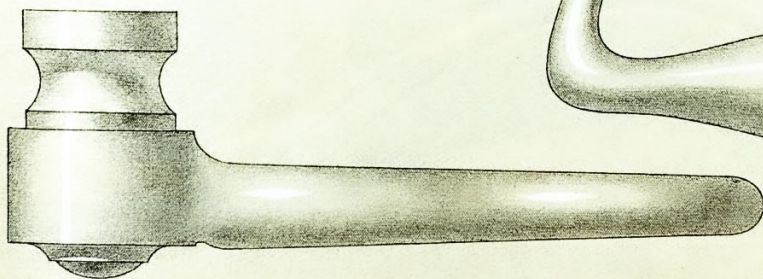
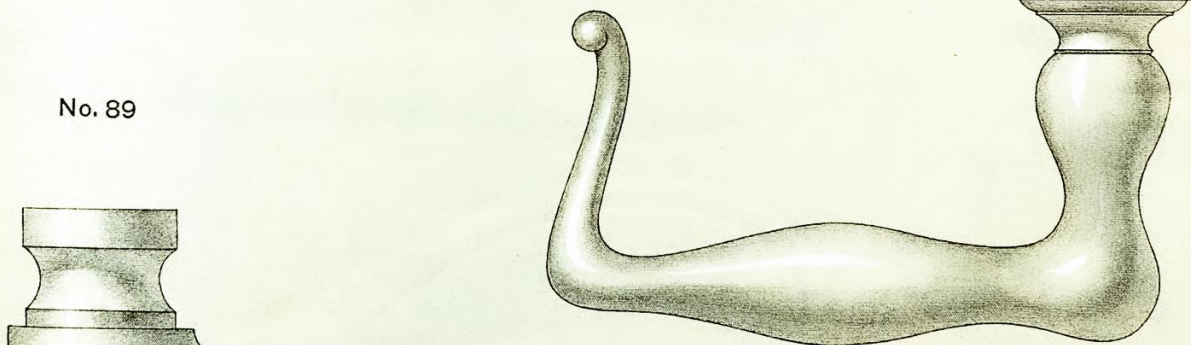
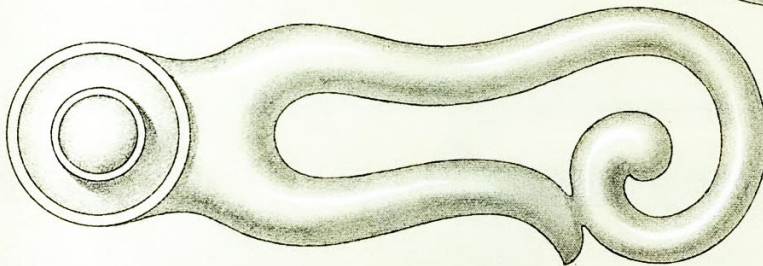

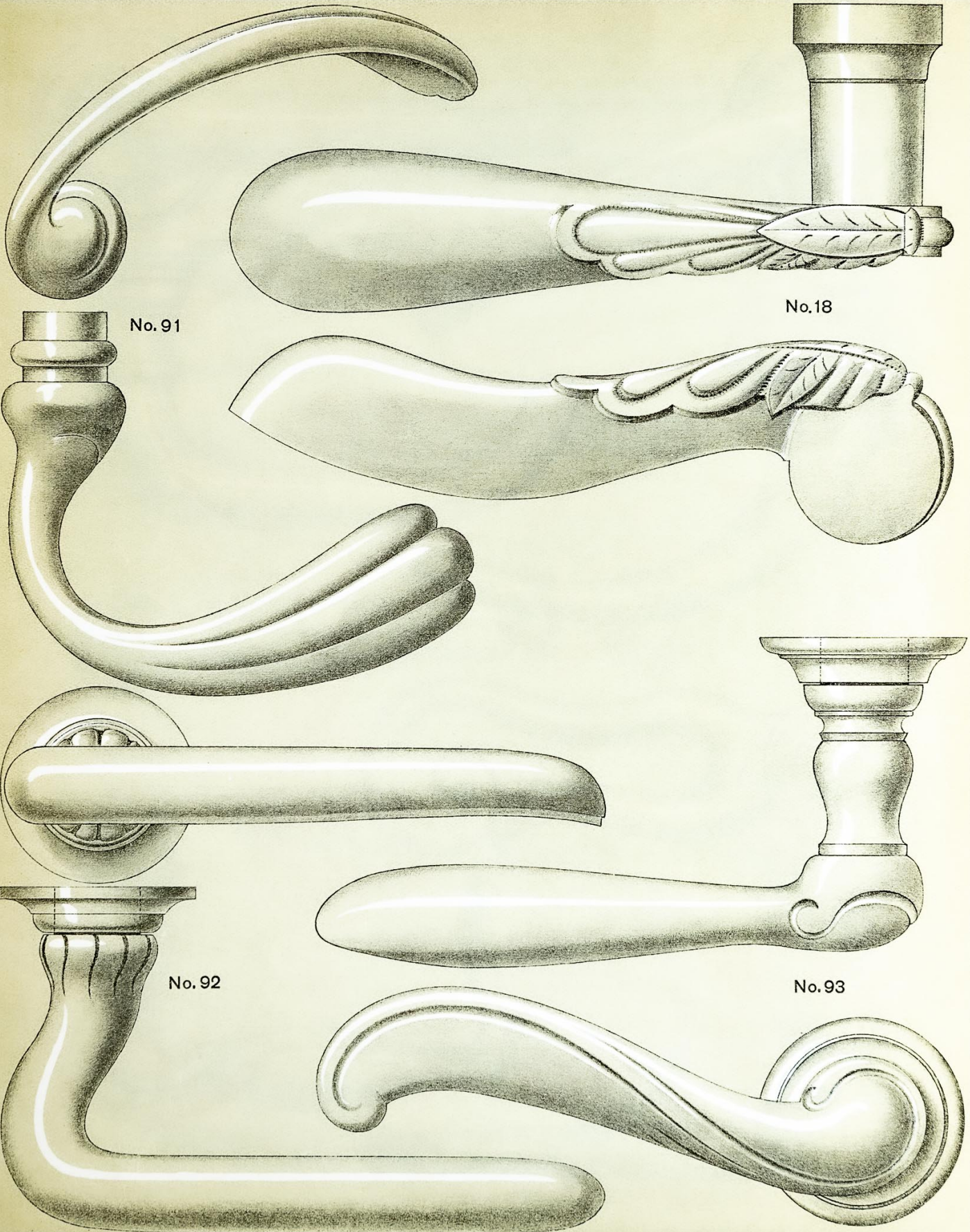

No.94

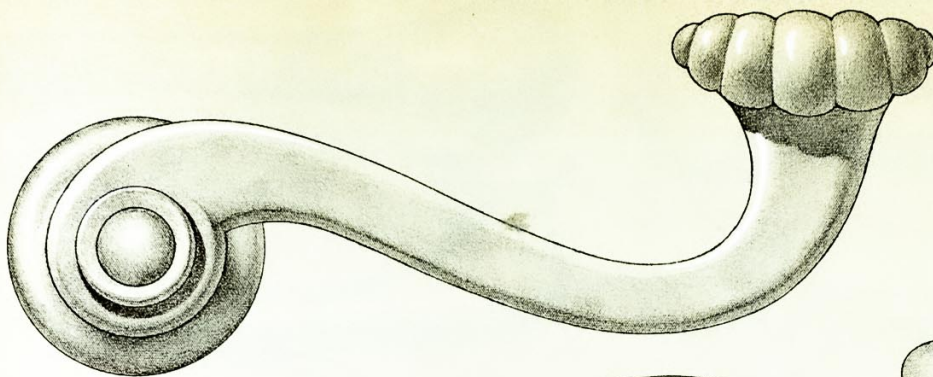

No. 96

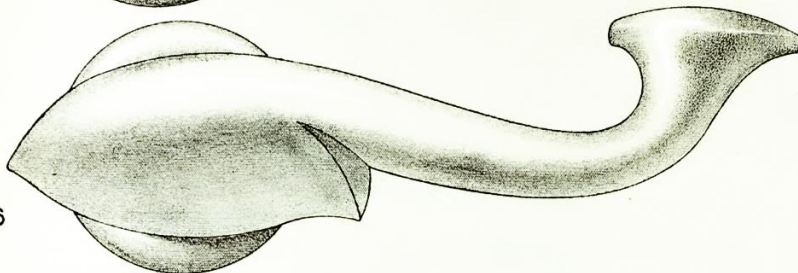

No. 95

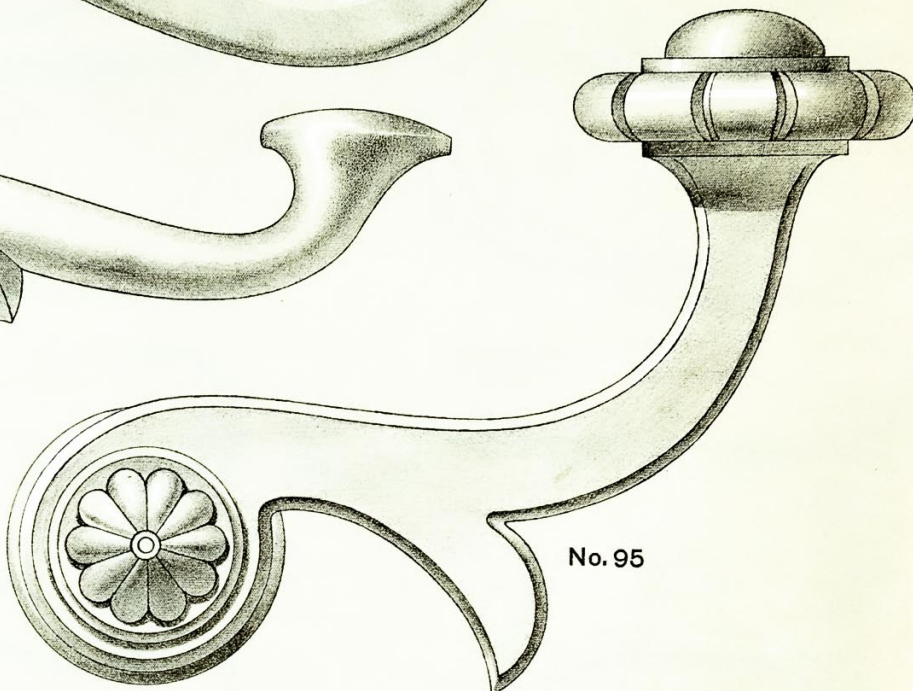

No. 94

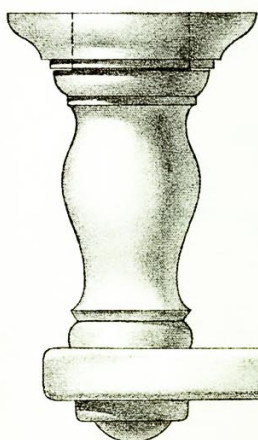

No. 95

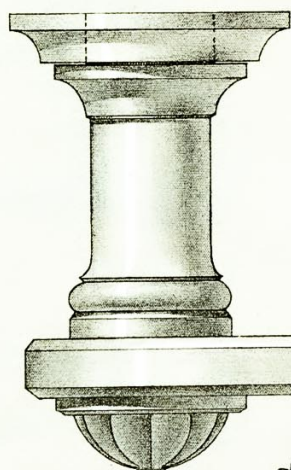

No. 96

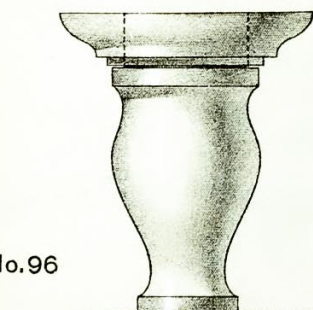

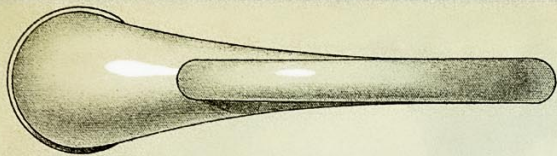

No.20

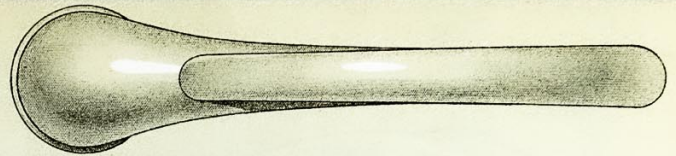
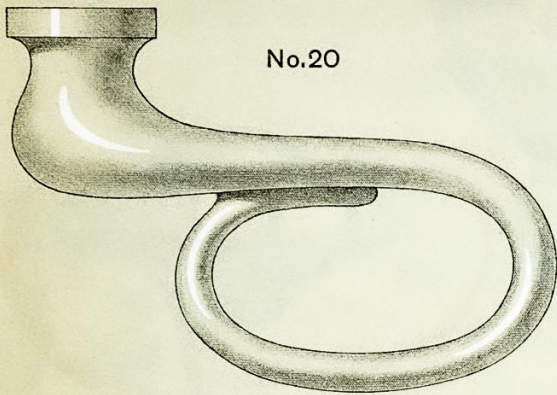

No.20½

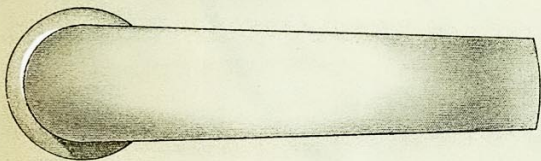
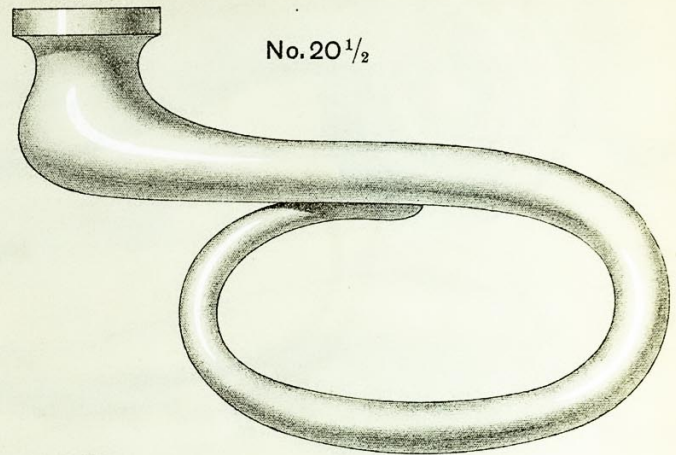

No.25

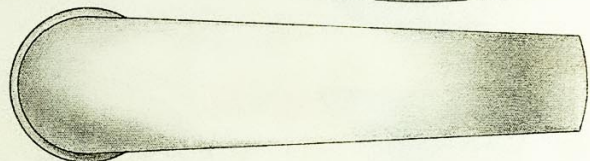
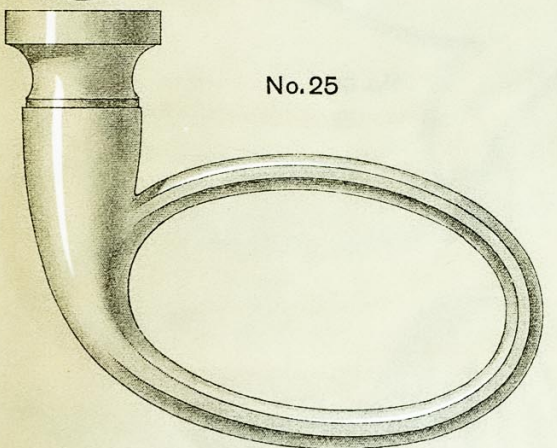

No.25½

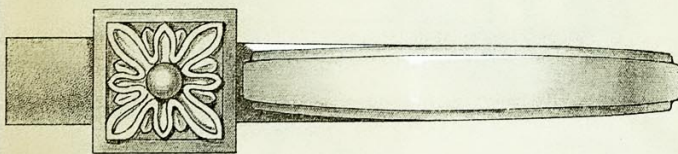
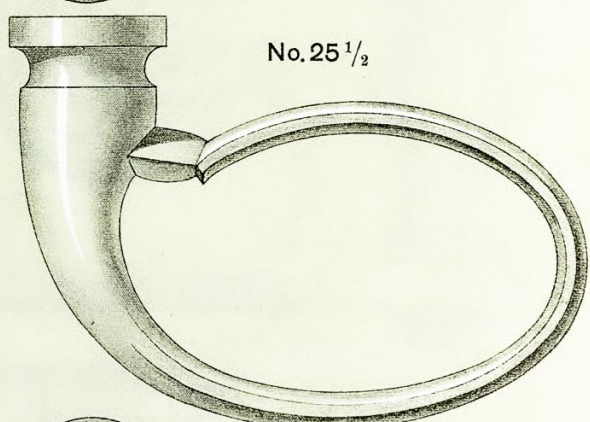

No.97

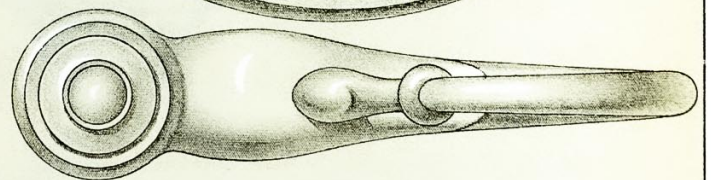
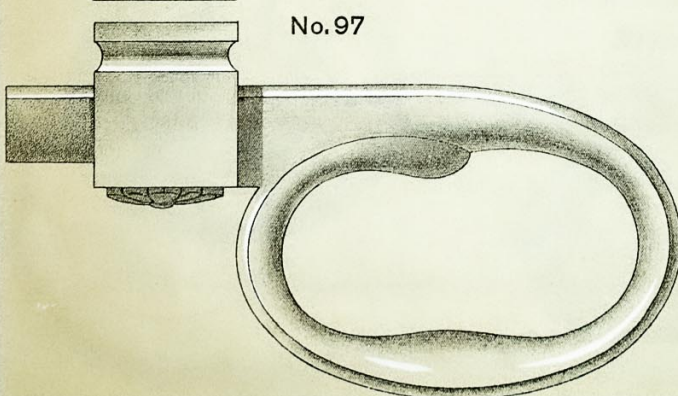

No.98

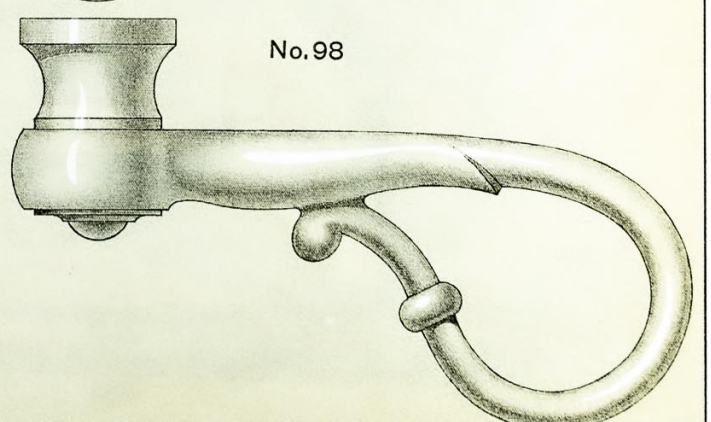

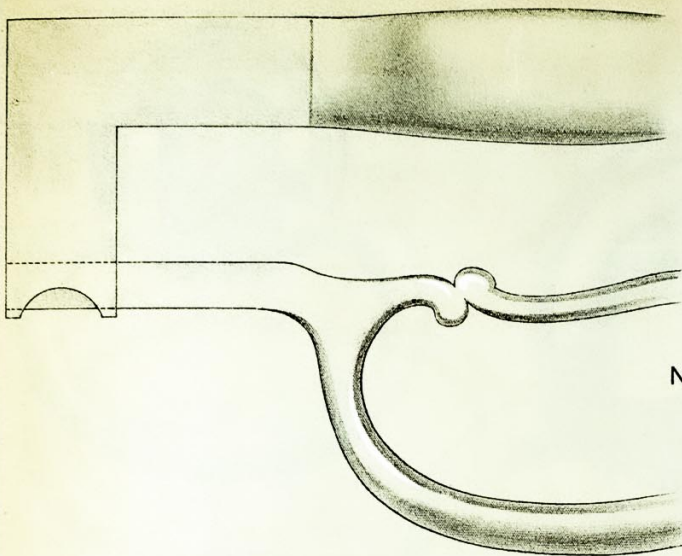

No.24

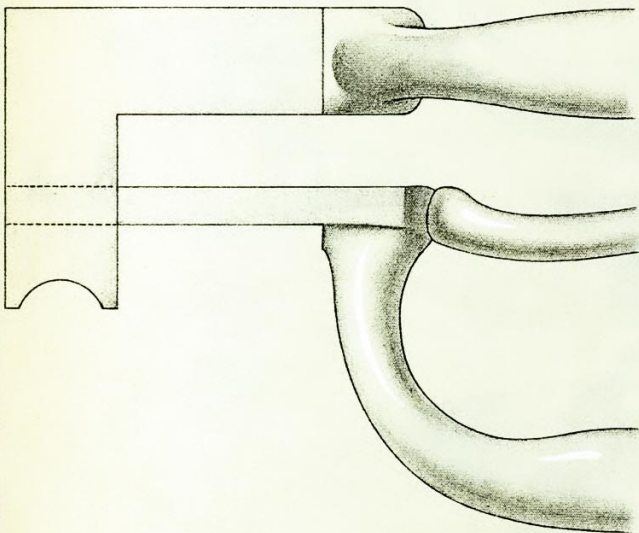
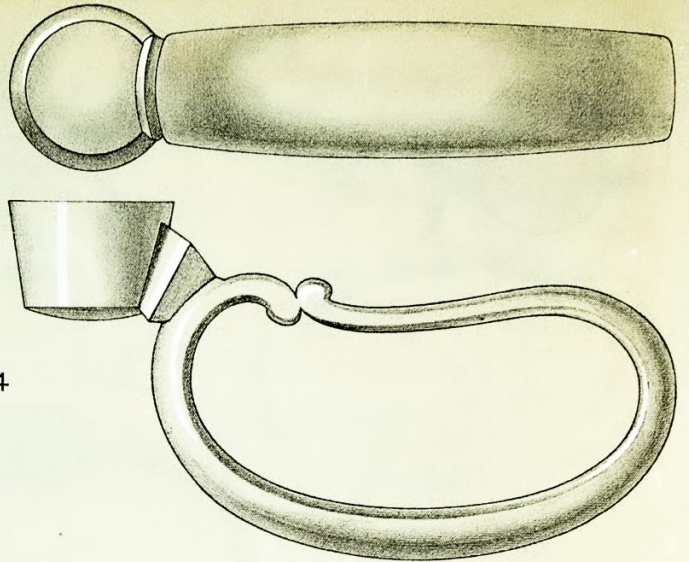

No.27

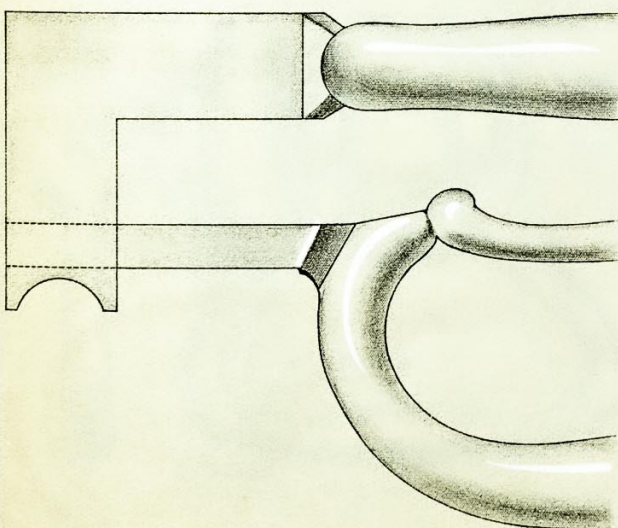
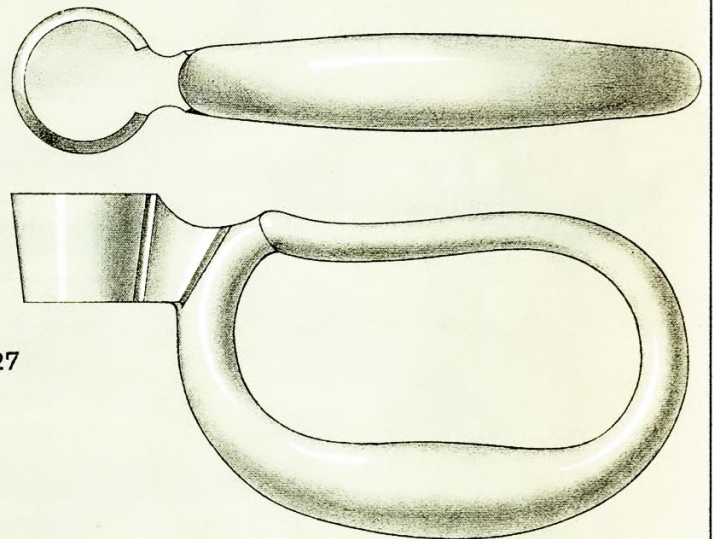

No.27 1/2

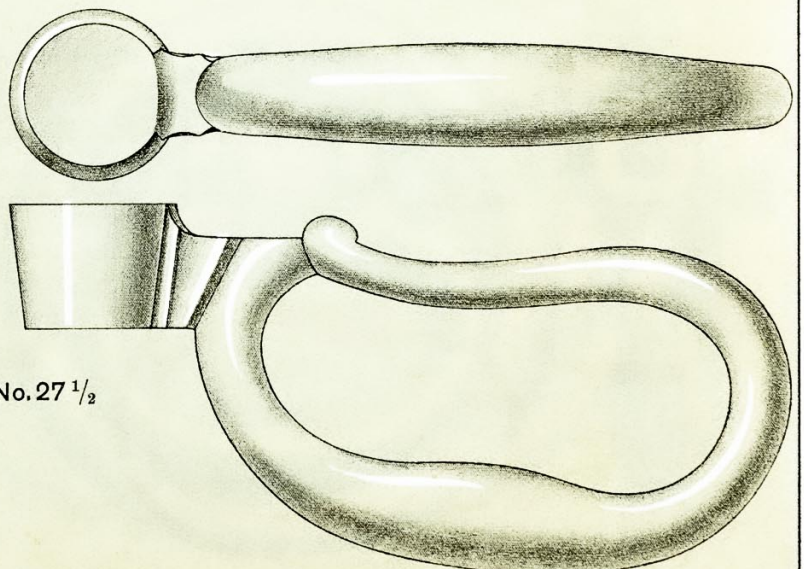

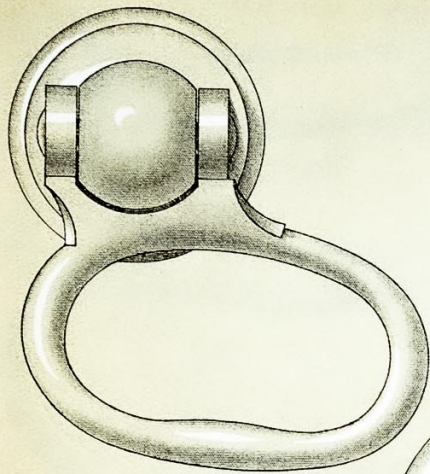

No.185

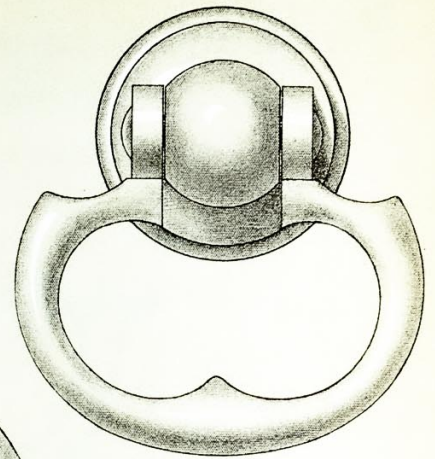

No.186

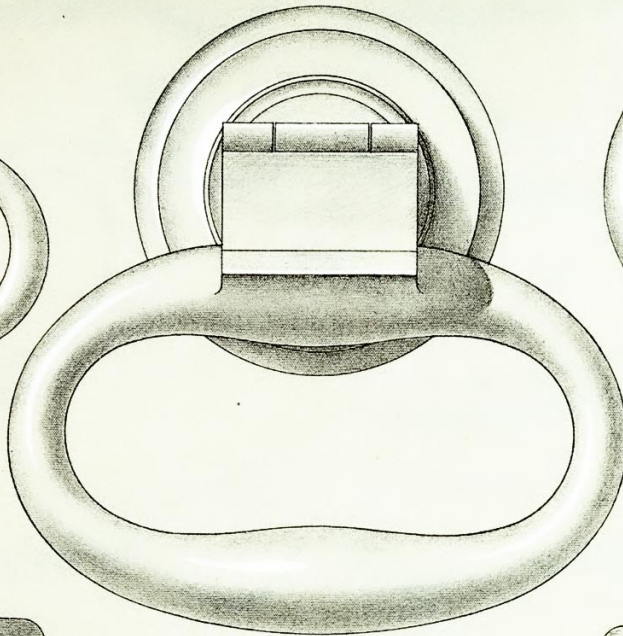

No.187

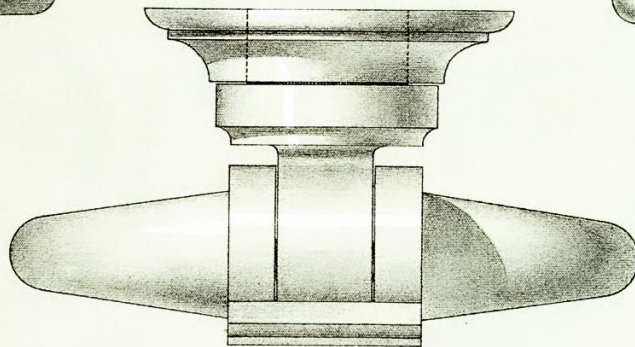
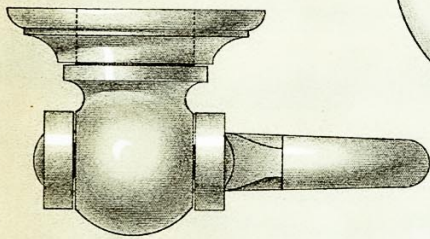

No.188

No.189

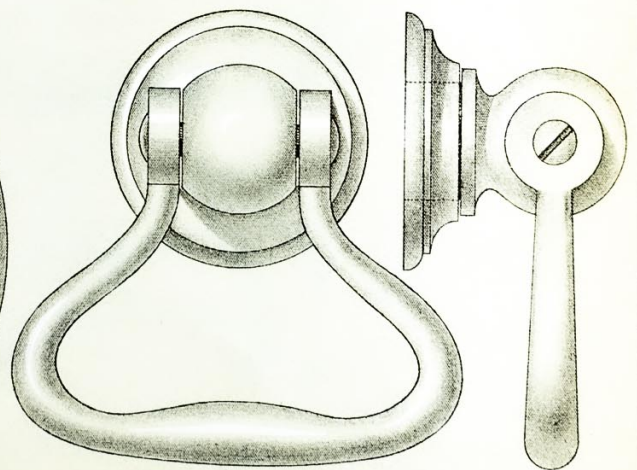
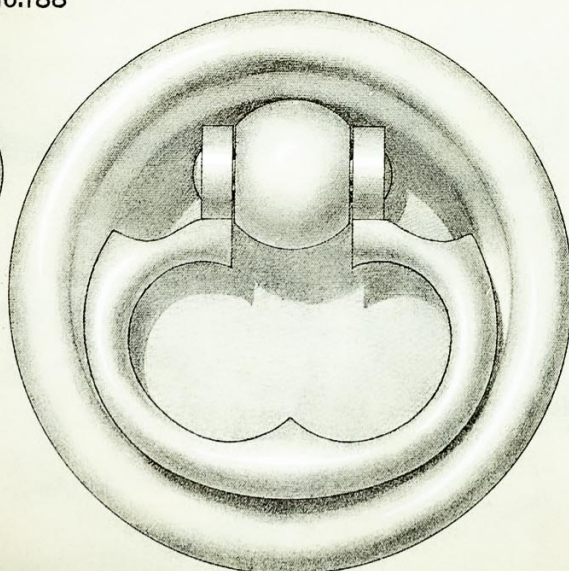
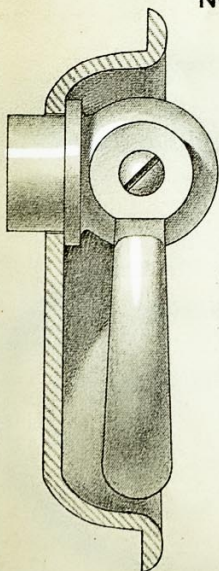

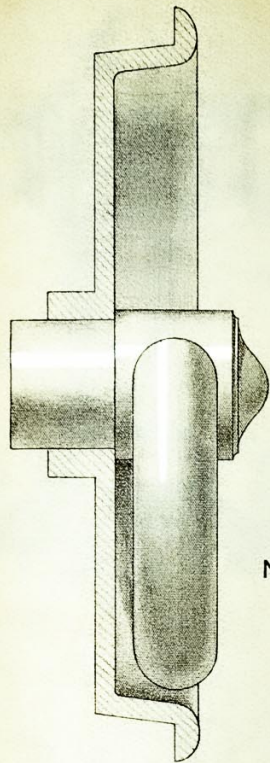

No. 190

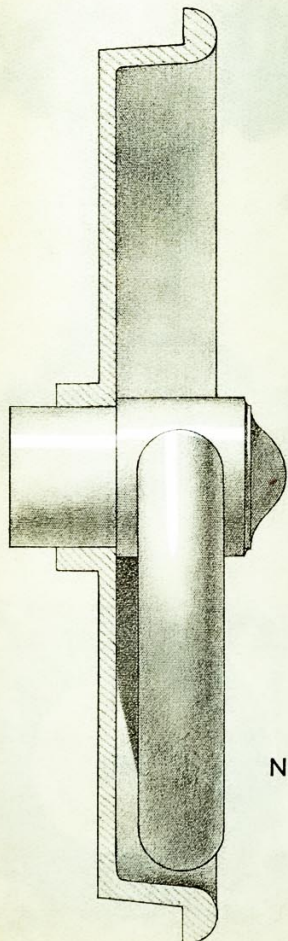
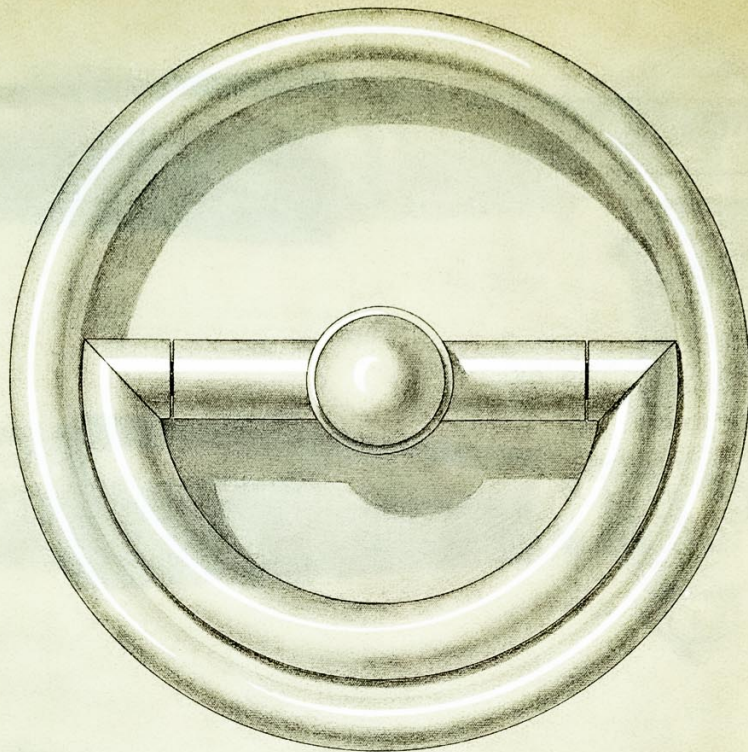

No. 191

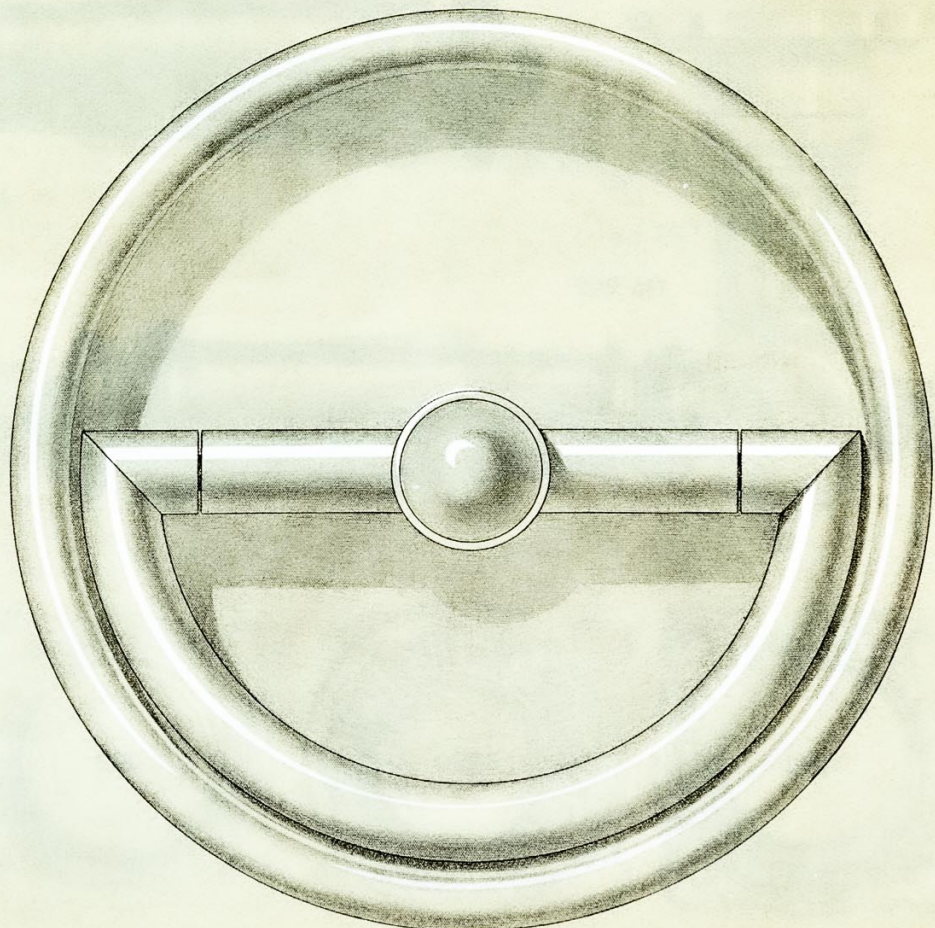

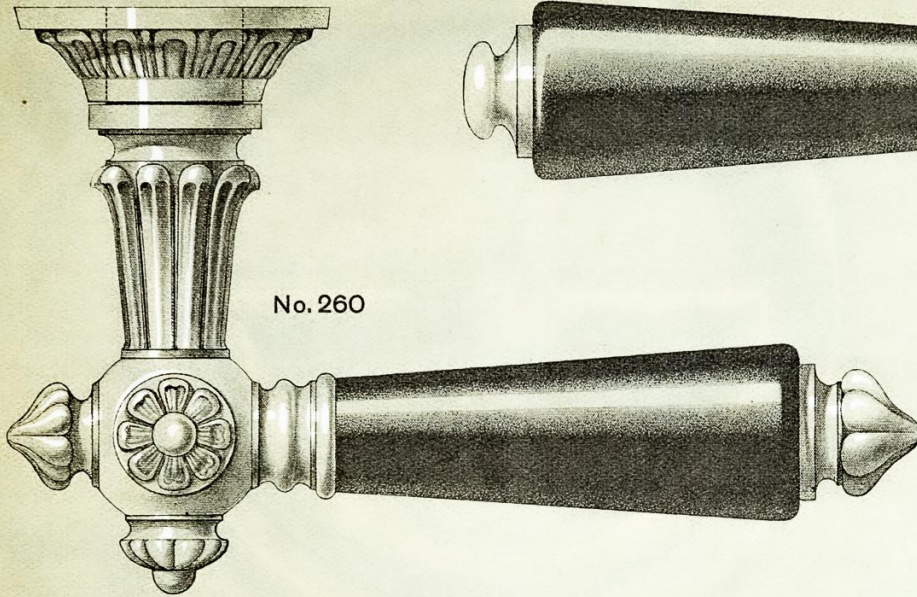

No. 260

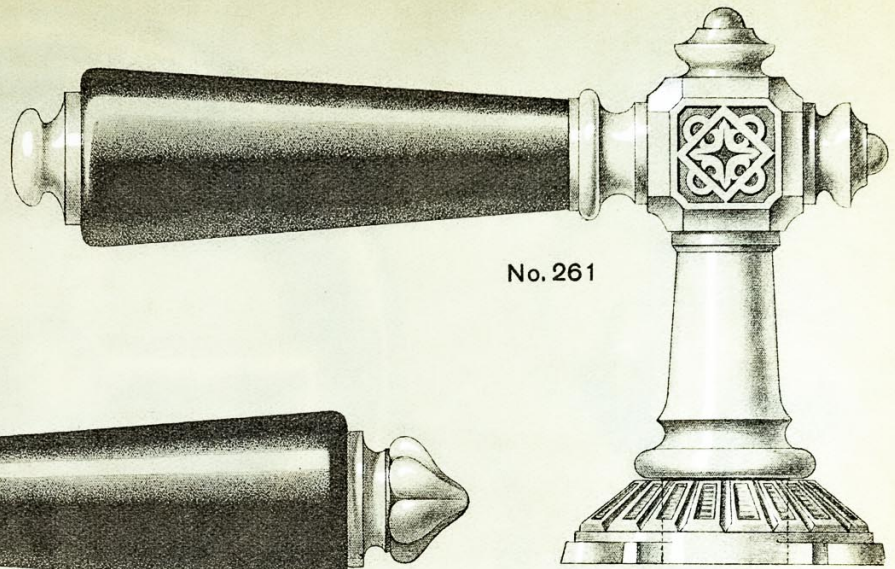

No. 261

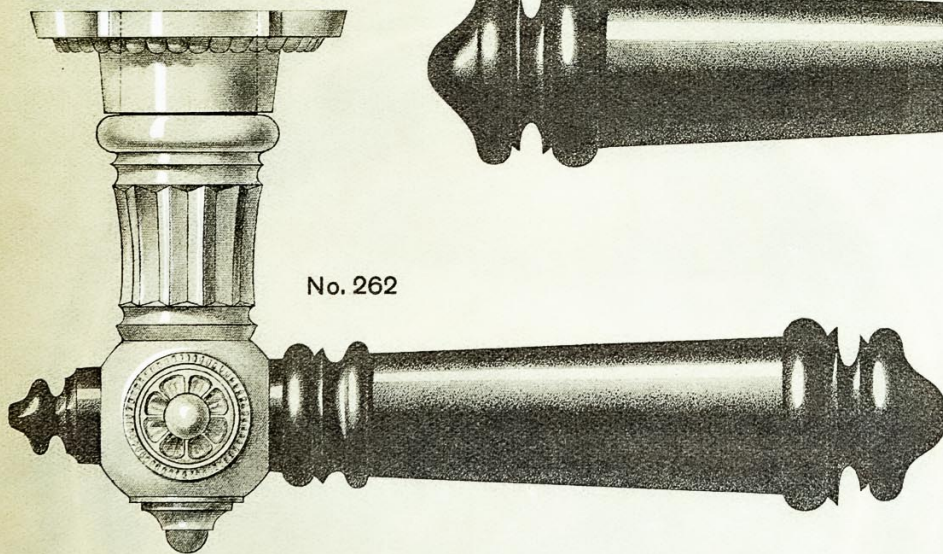

No. 262

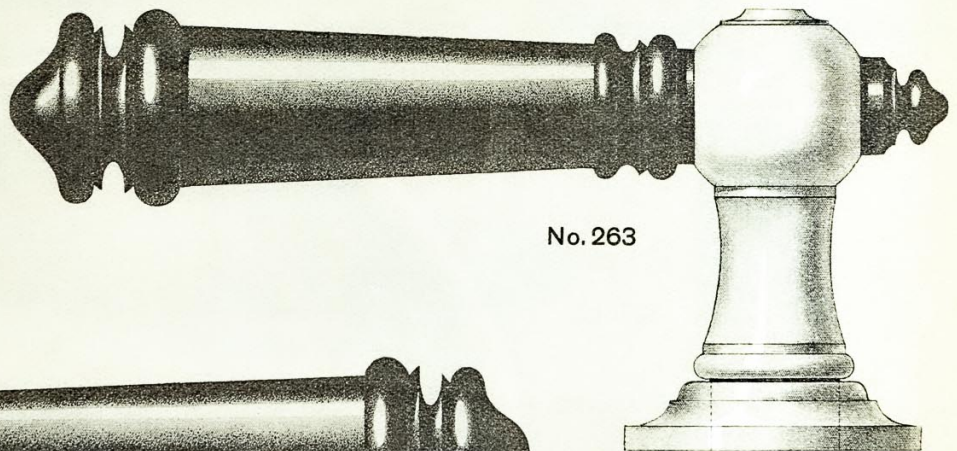

No. 263

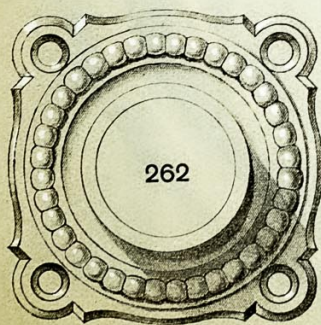

262

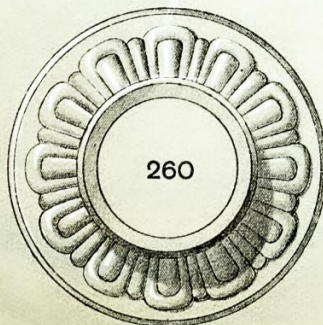

260

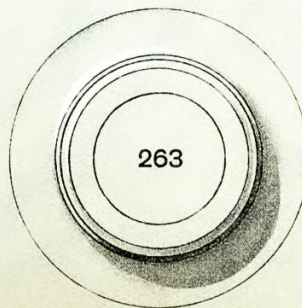

263

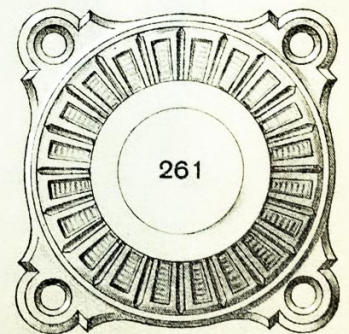

261

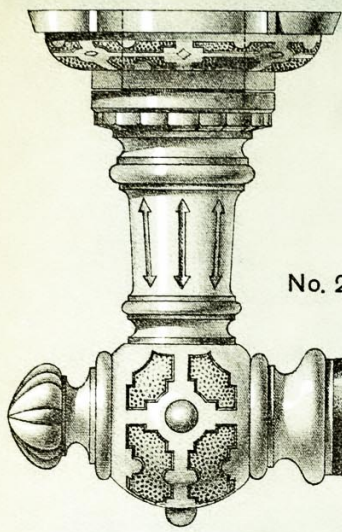

No. 264

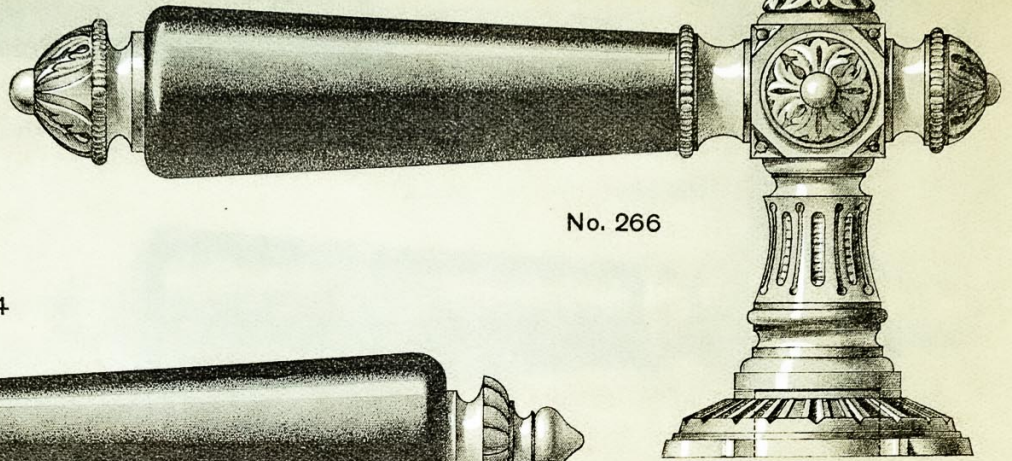

No. 266

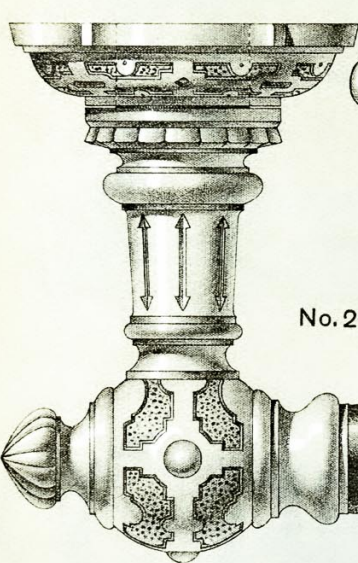

No. 265

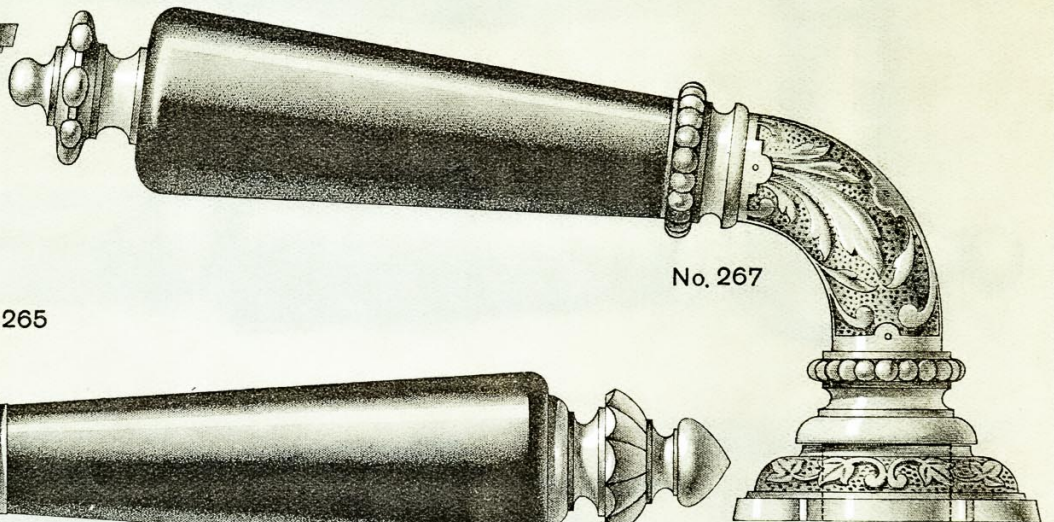

No. 267

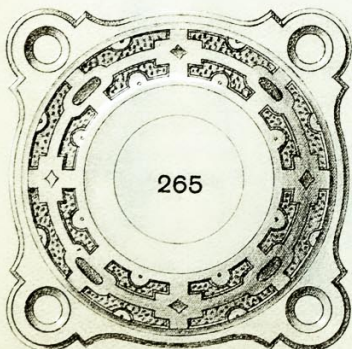

265

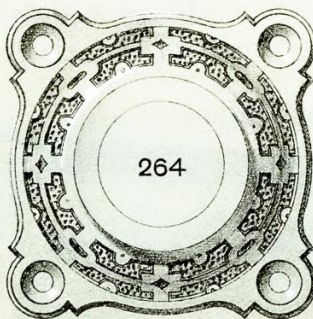

264

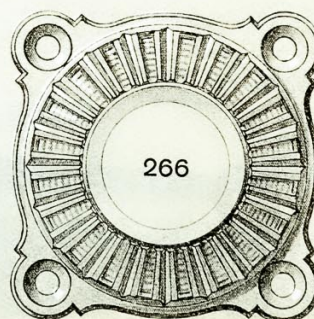

266

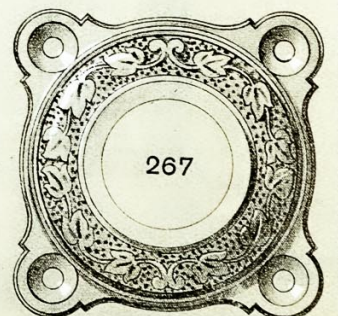

267



No. 68 (Horn-Corne 62 mm)

No. 68 a (" " 68 mm)

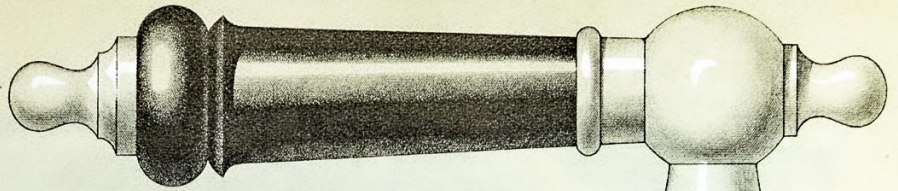

No. 35

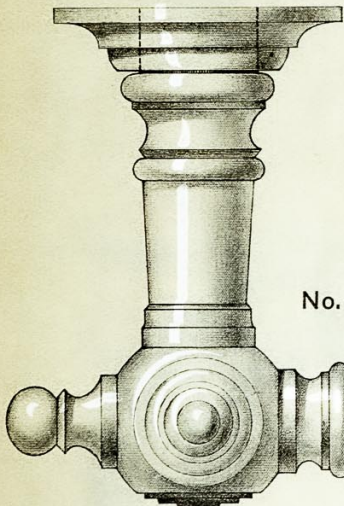
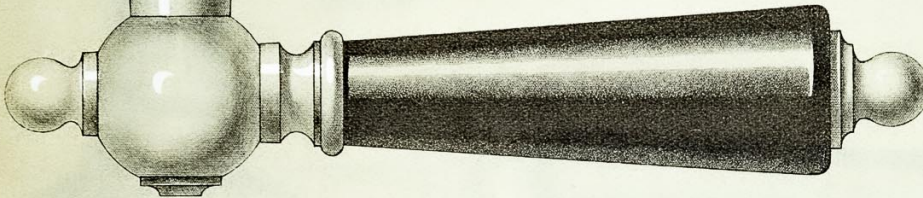

No. 63

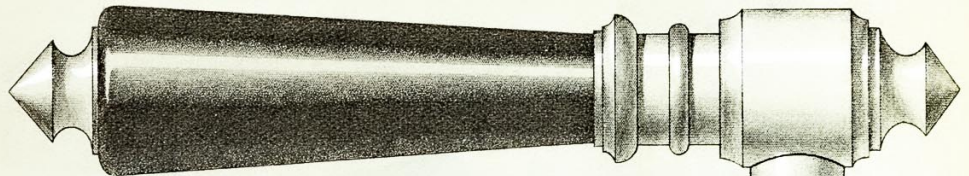

No. 38

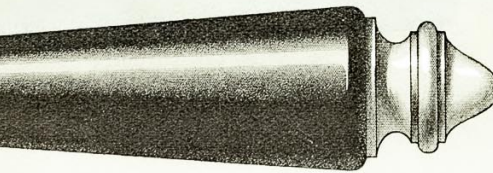

No. 69 Ges. gesch.
Déposé



No. 54 (Horn-Corne 62 mm)

No. 54 a (" " 68 mm)

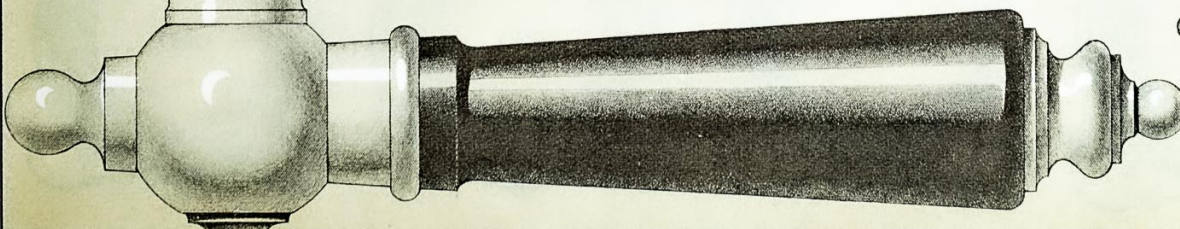

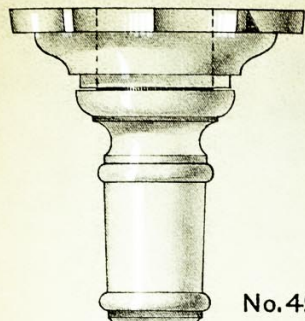

No. 42

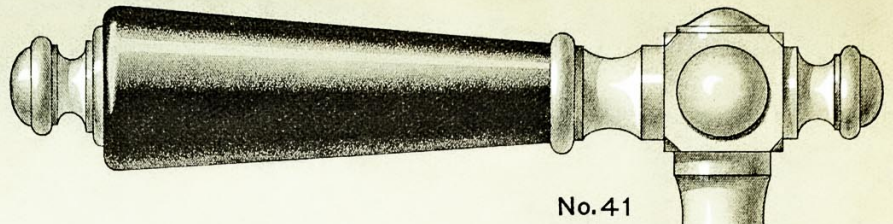

No. 41

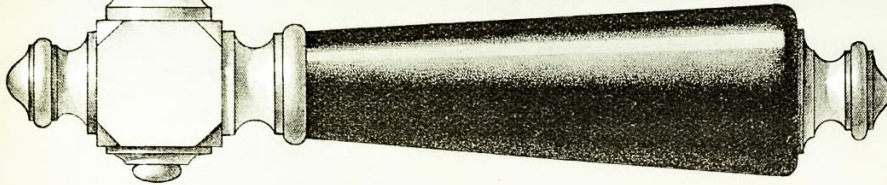

No. 42 1/2

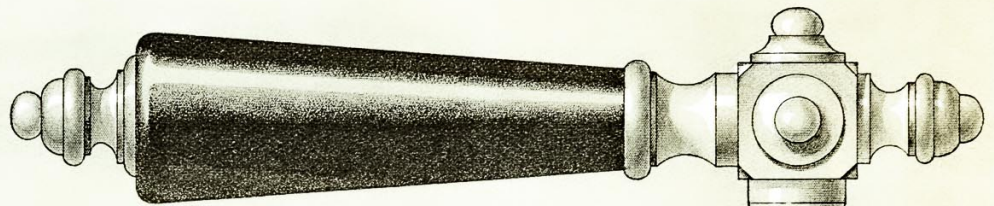

No. 41 1/4

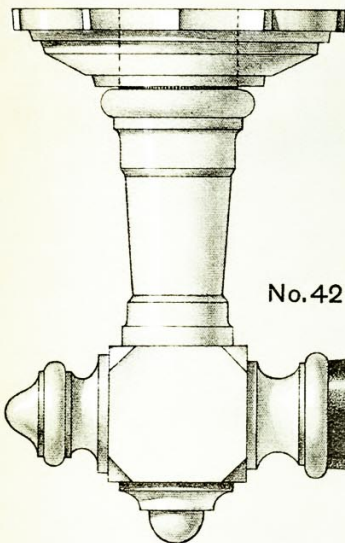

No. 59

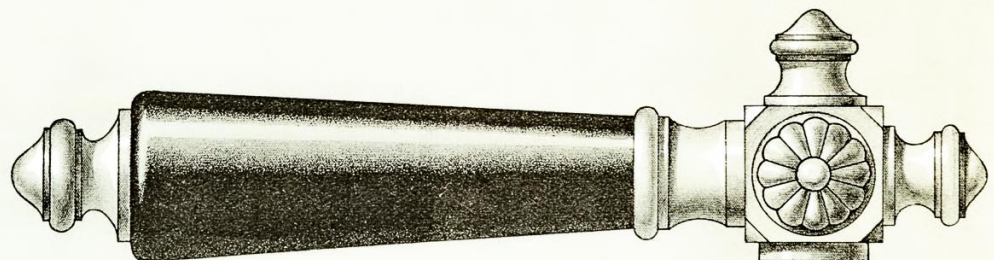

No. 67 No. 67 1/2
 ohne mit
 Cannelierung
 sans avec
 Cannelure

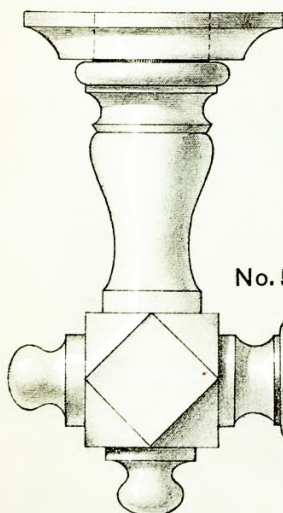

Gesetzlich geschützt No. 67 1/2 Déposé



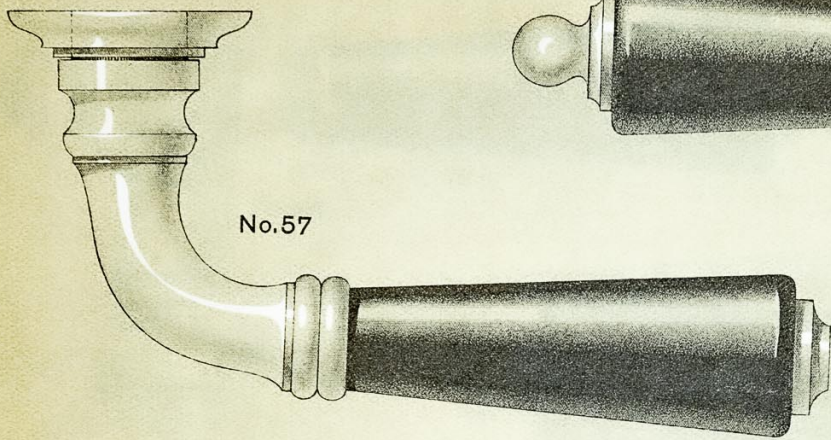

No.57

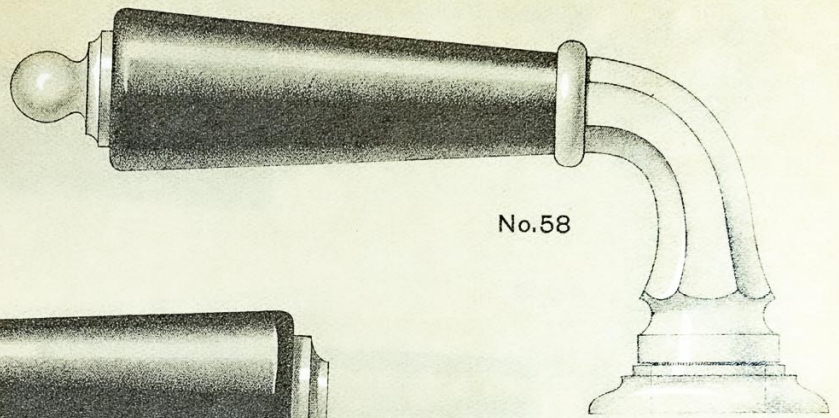

No.58

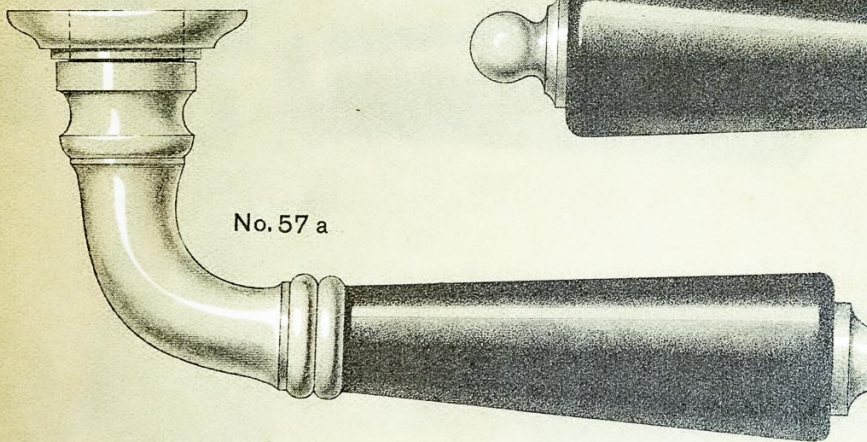

No.57 a

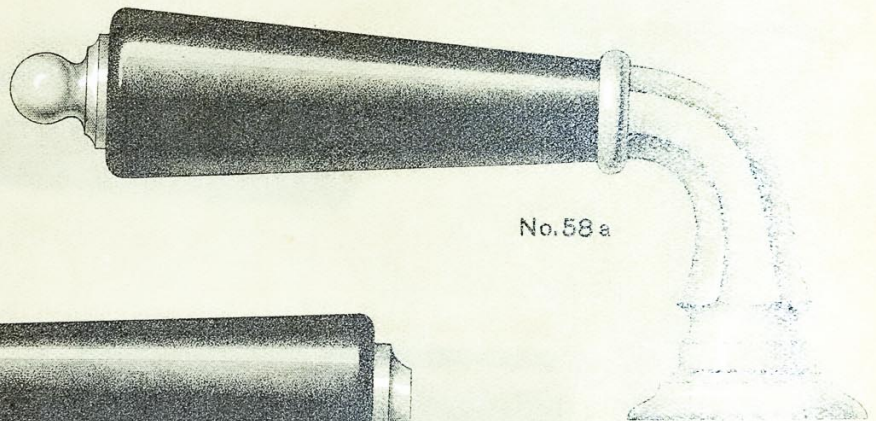

No.58 a

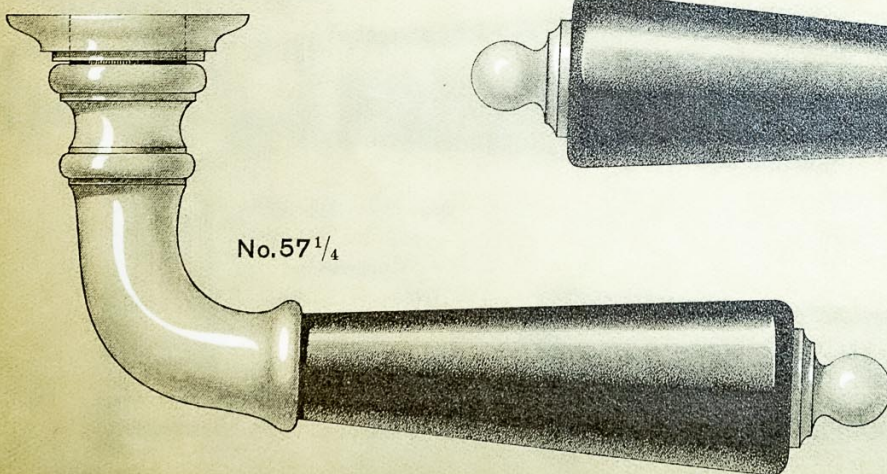

No.57 1/4

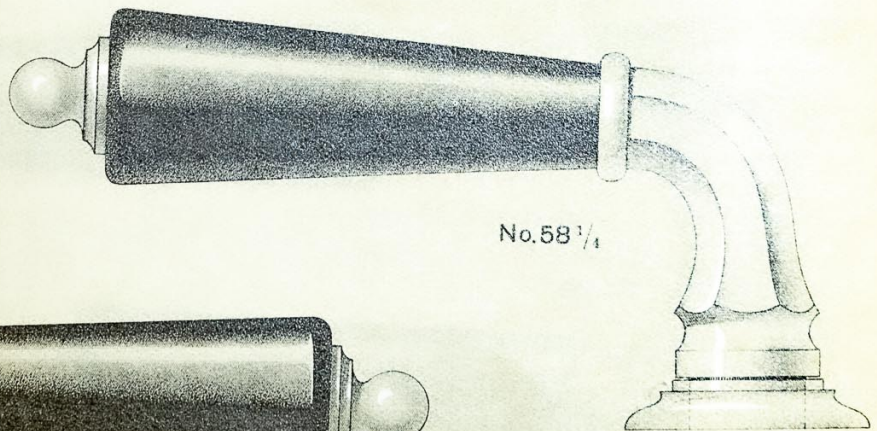

No.58 1/4

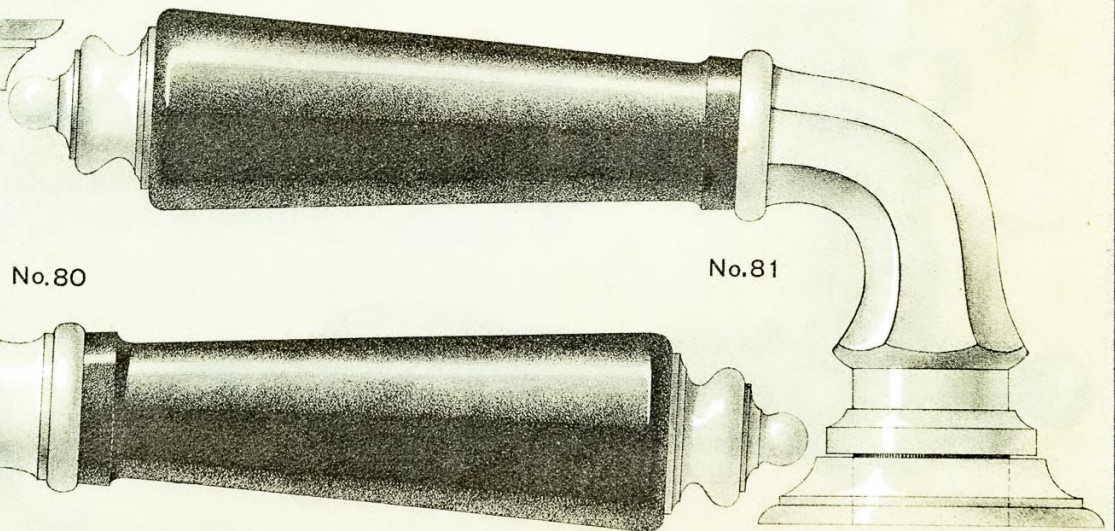
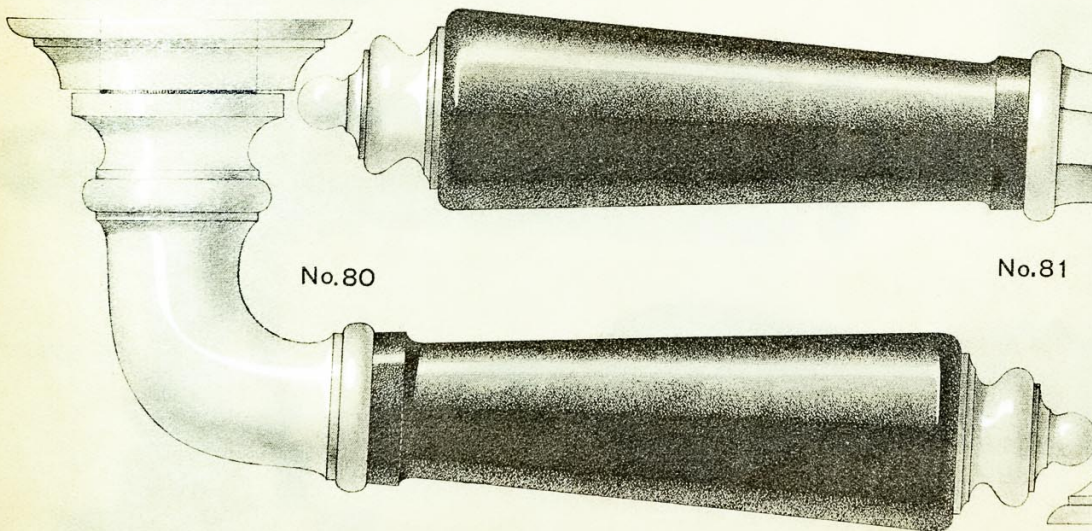
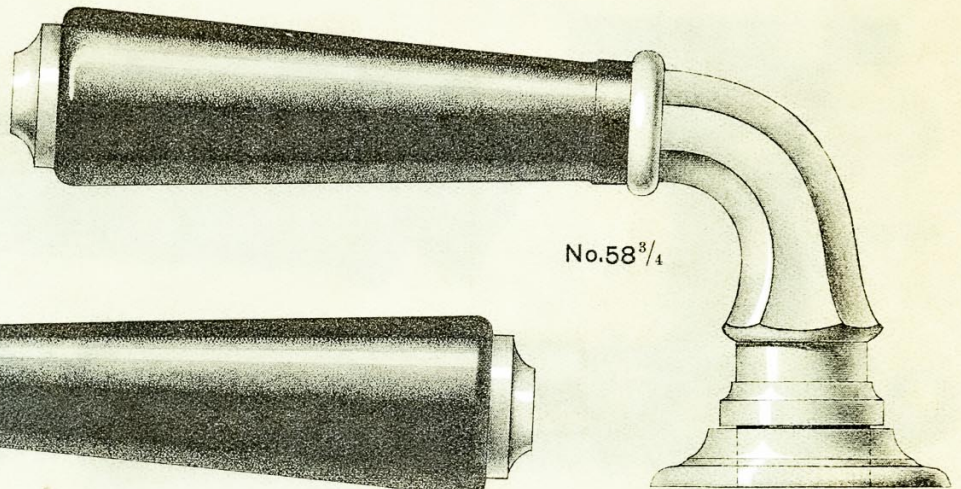
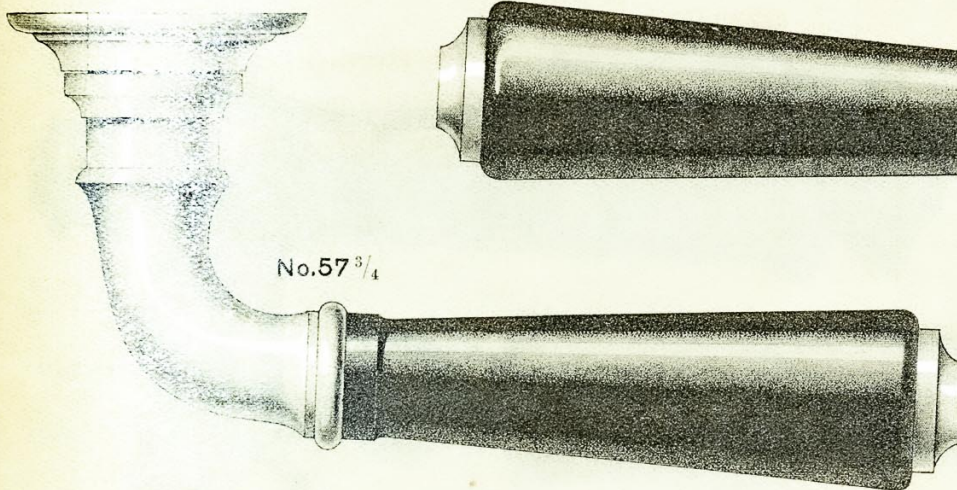
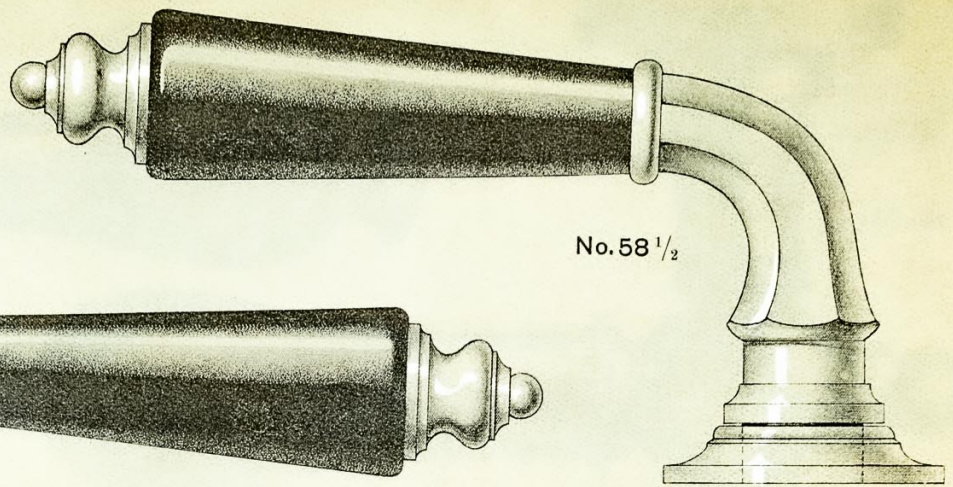
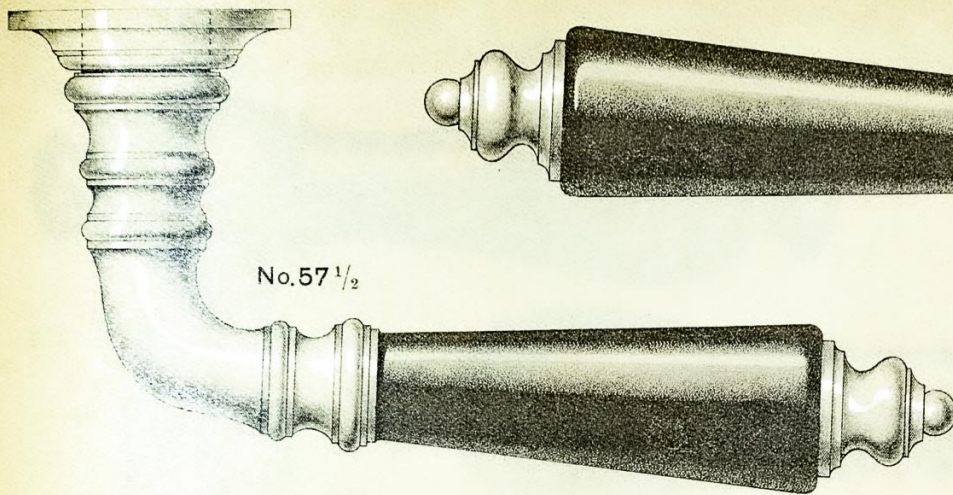

Gesetzlich geschützt No. 80, 81 Déposés



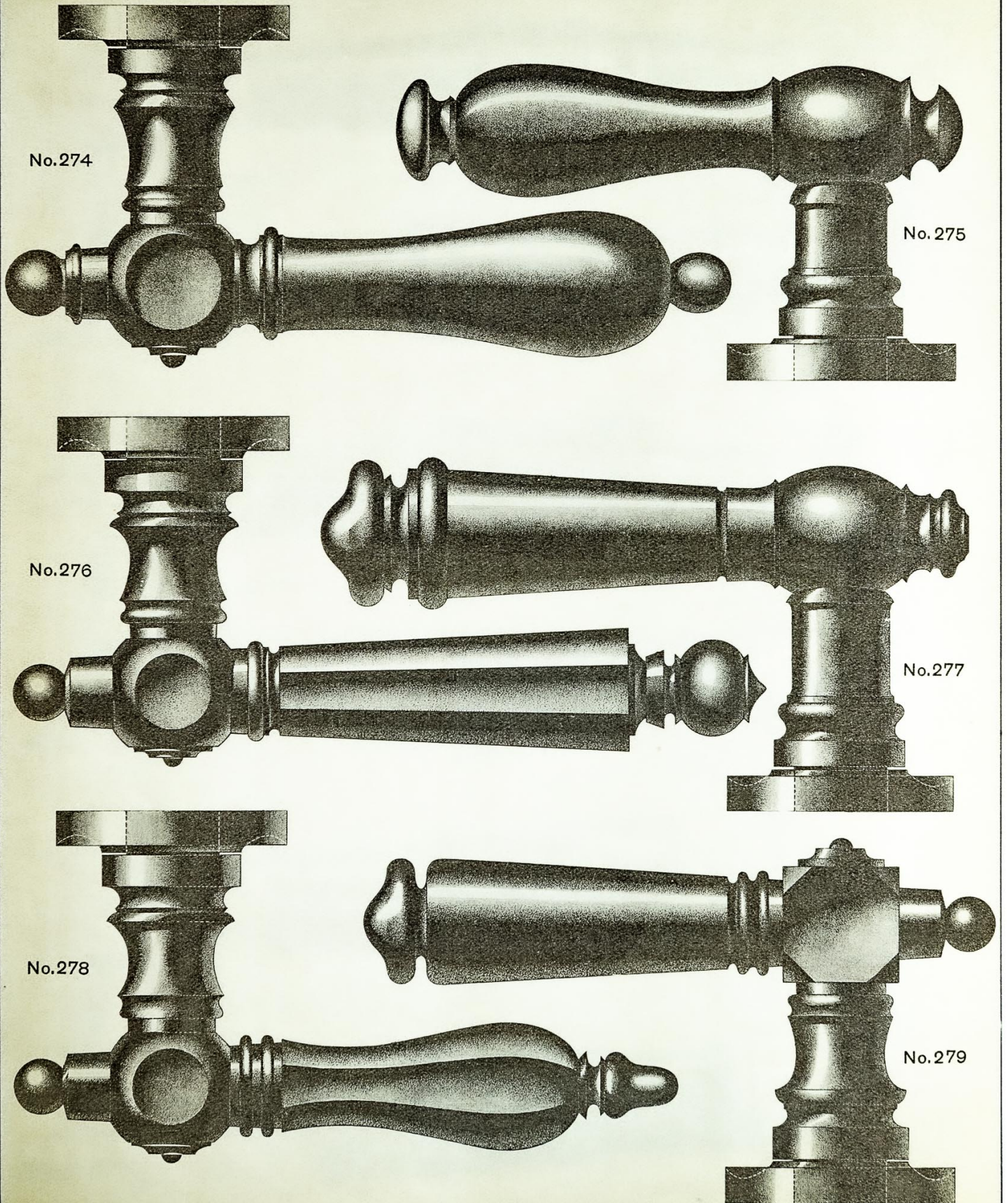

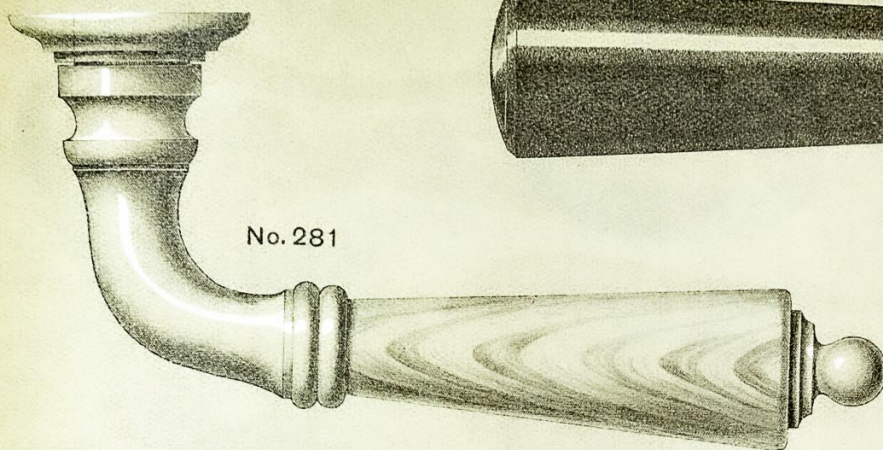

No. 281

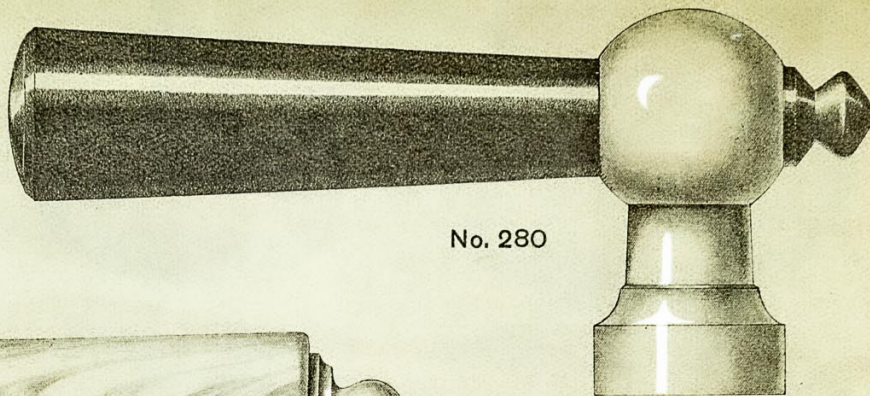

No. 280

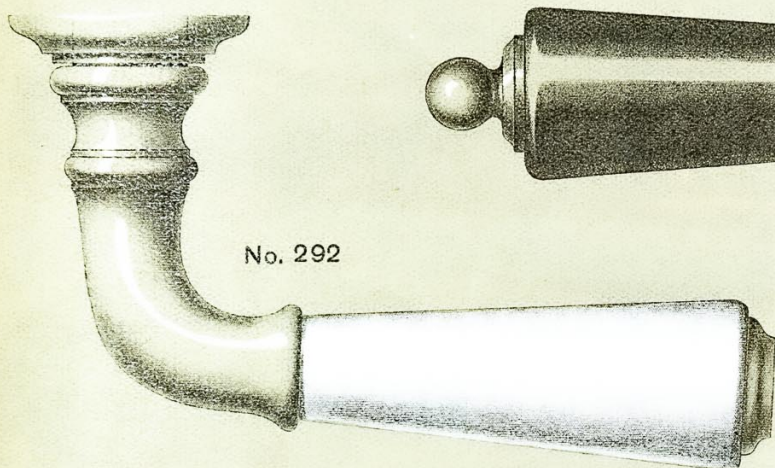

No. 292

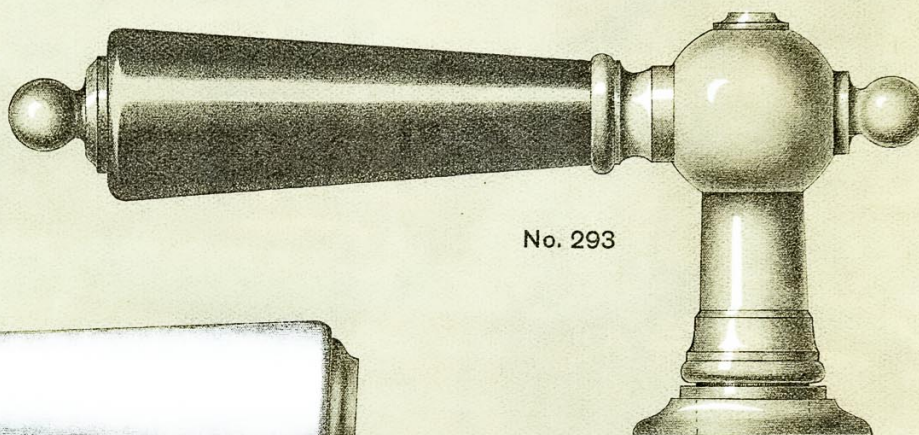

No. 293

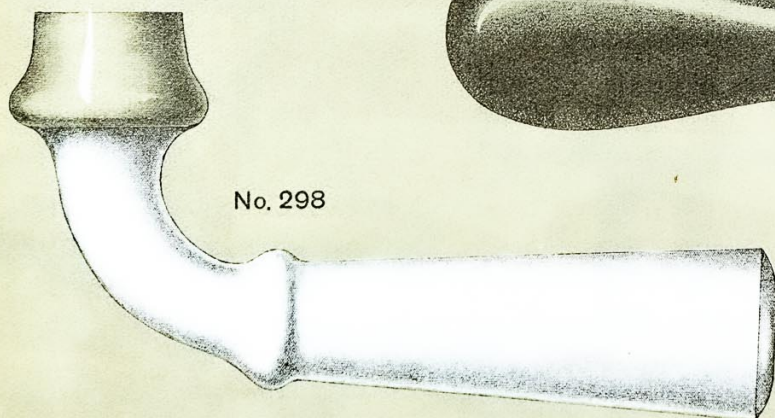

No. 298

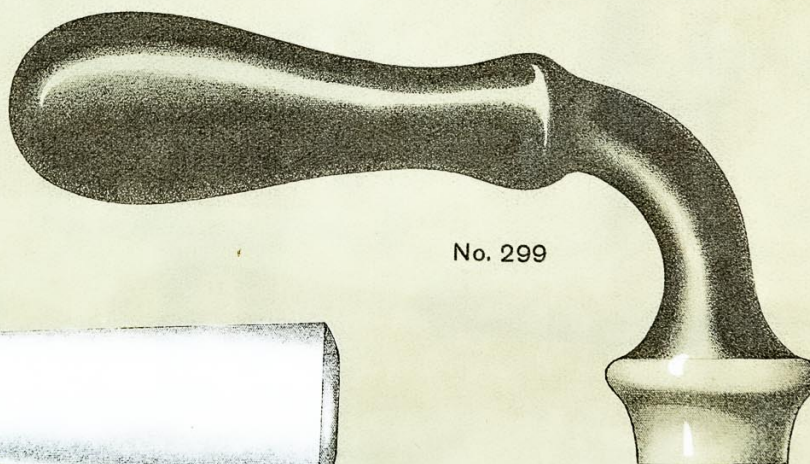

No. 299

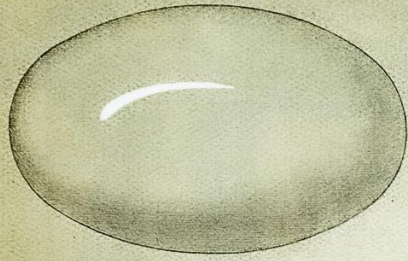

No. 302

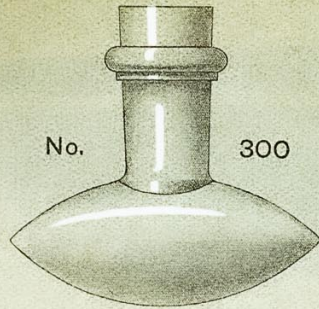

No. 300

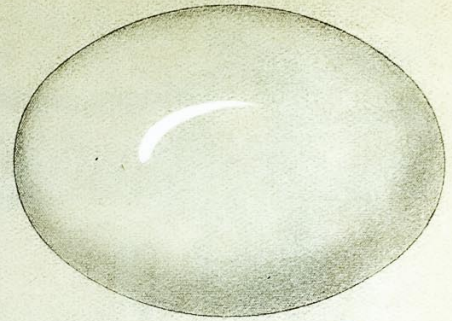

No. 303

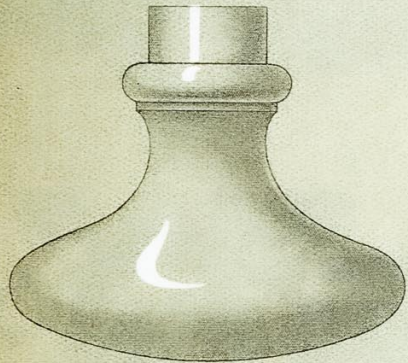

No. 301

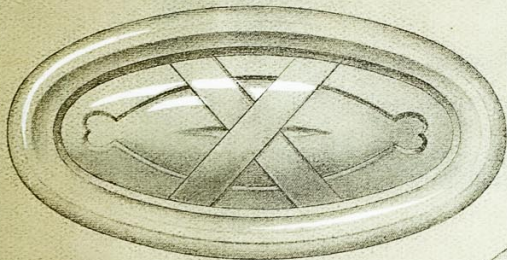
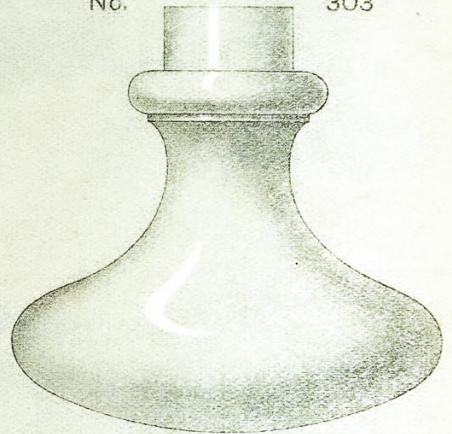

No. 307

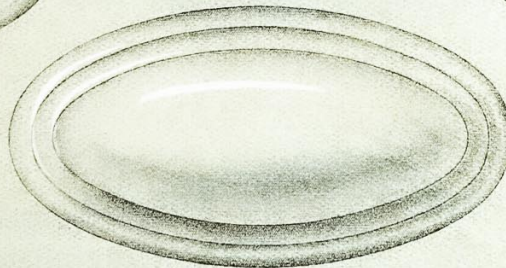
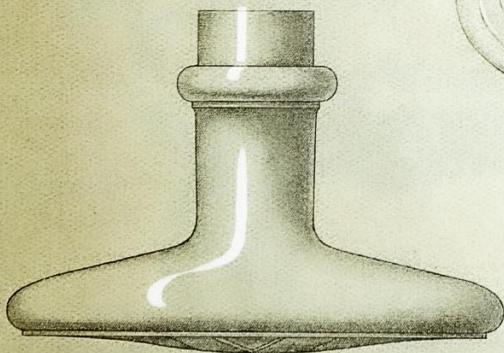
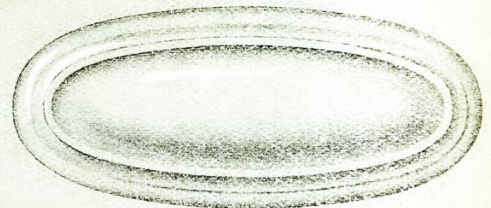
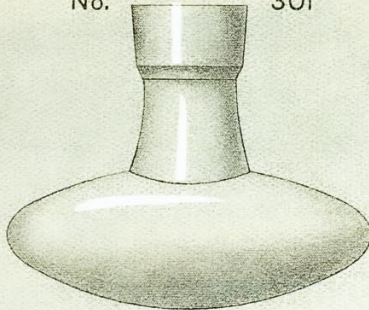

No. 306

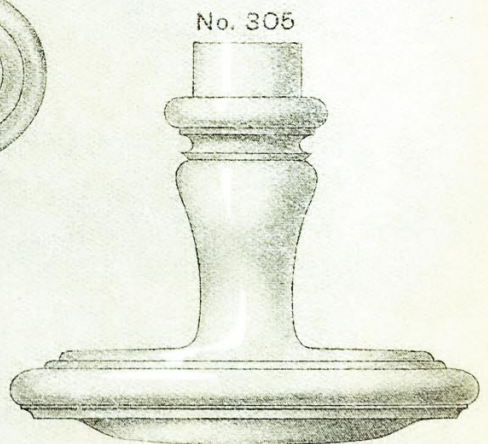

No. 305

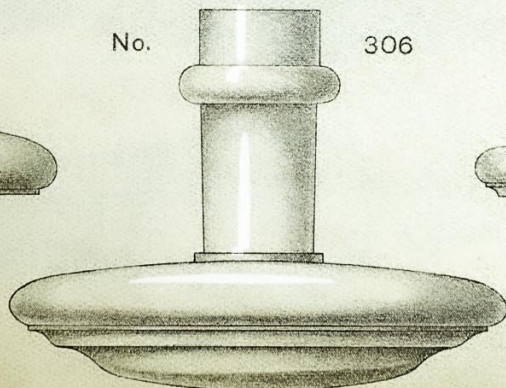

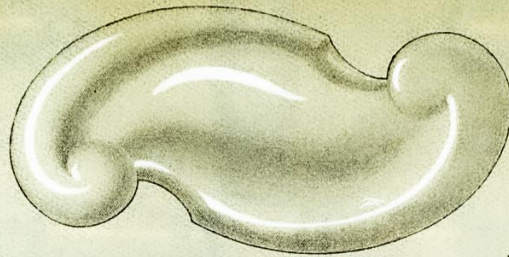
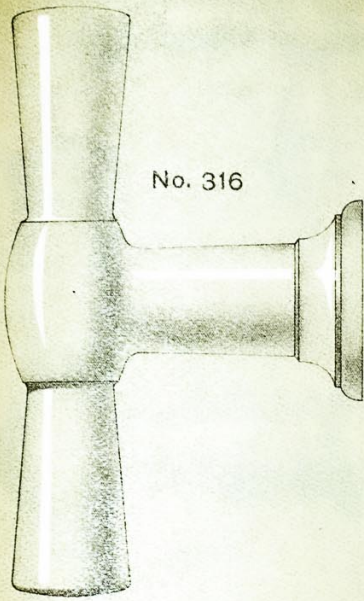

No. 310

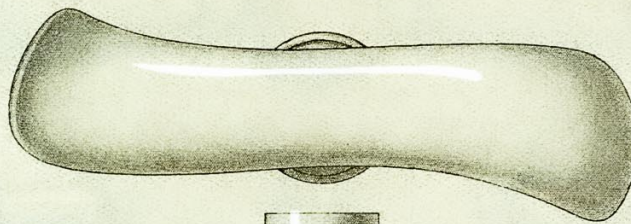
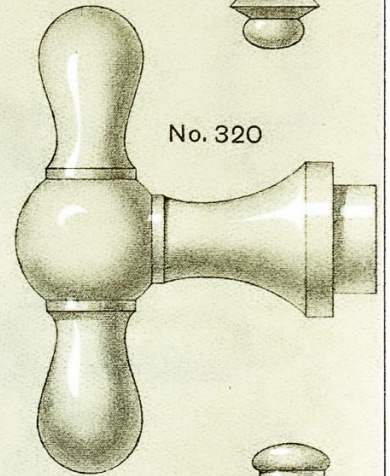
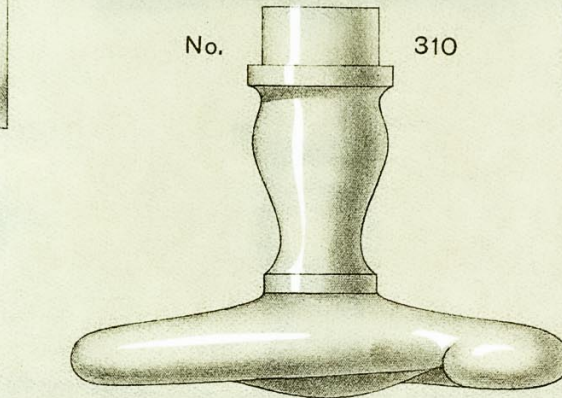
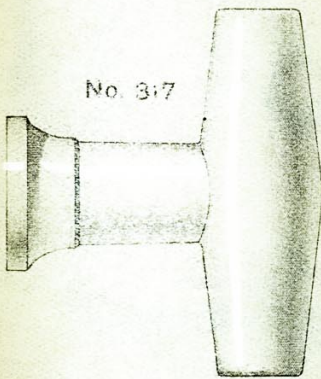
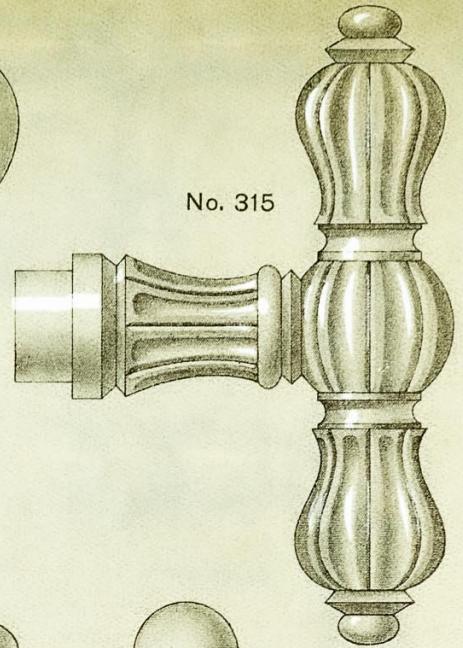

No. 312

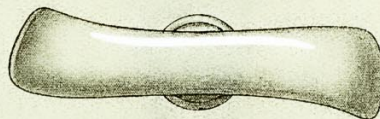
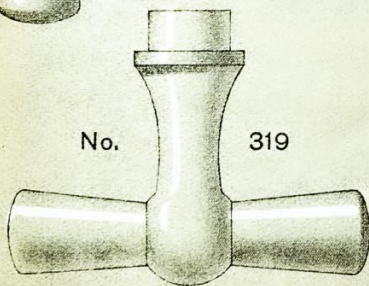
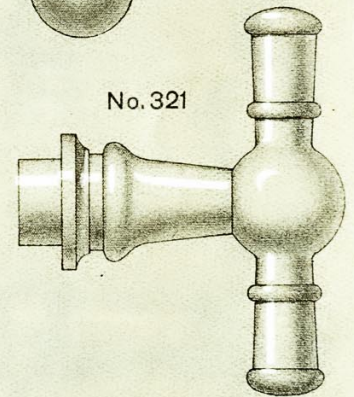
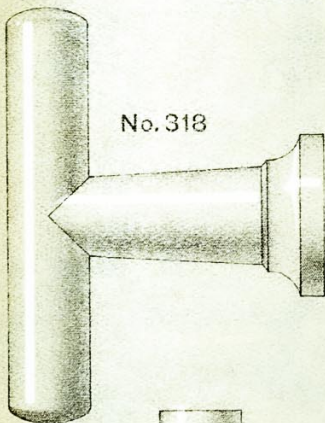

No. 313

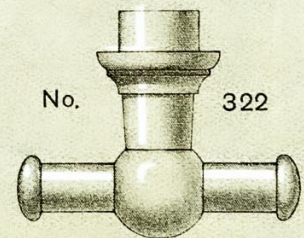
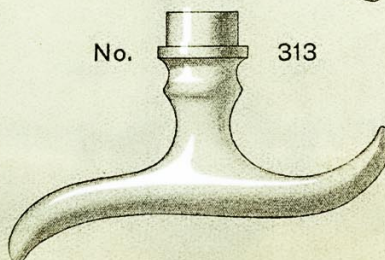

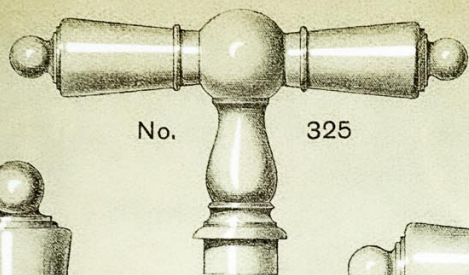

No. 326

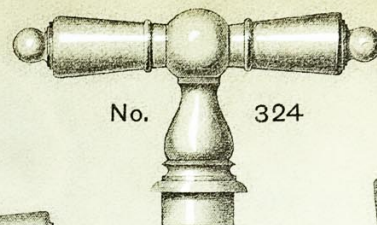

No. 324

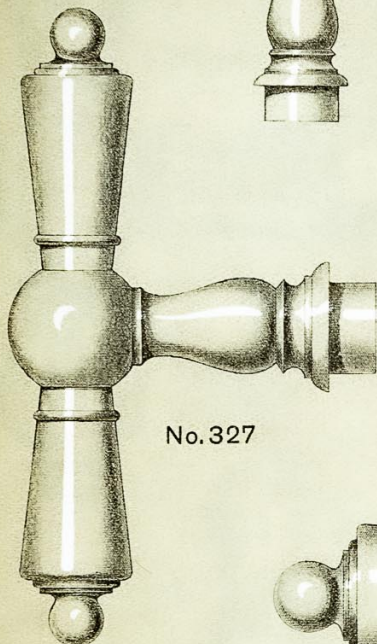

No. 327

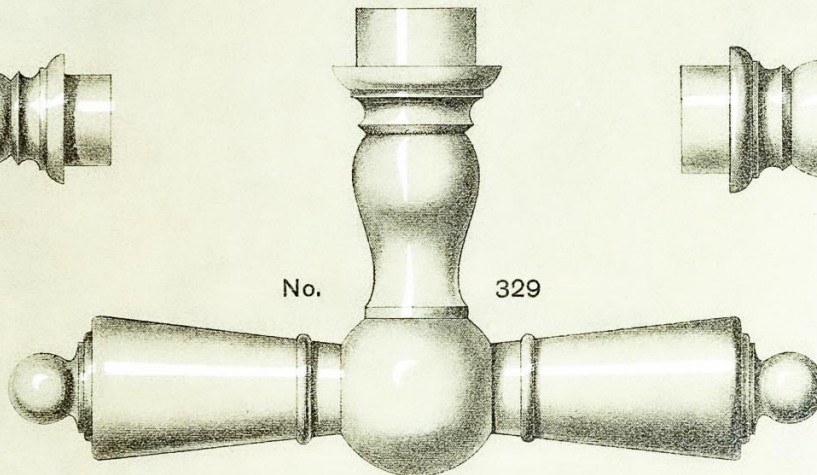

No. 329

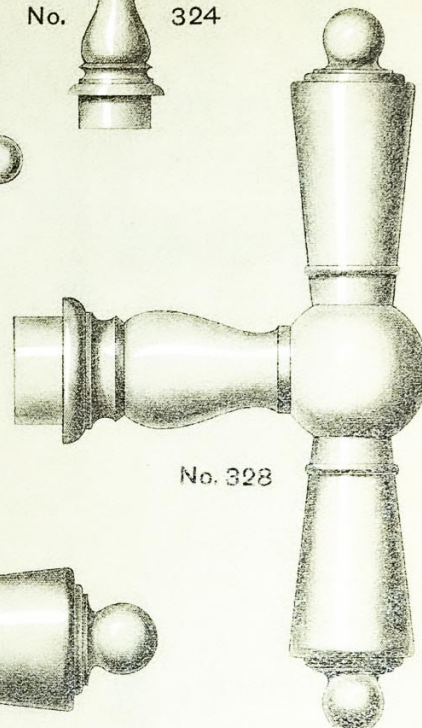

No. 328

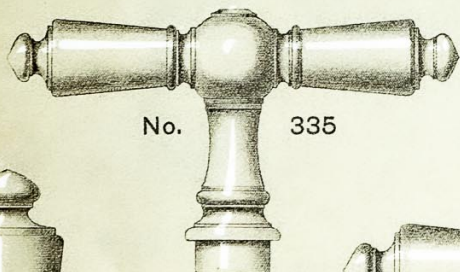

No. 335



No. 336

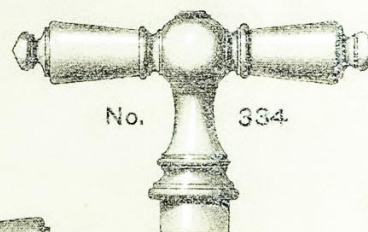

No. 334

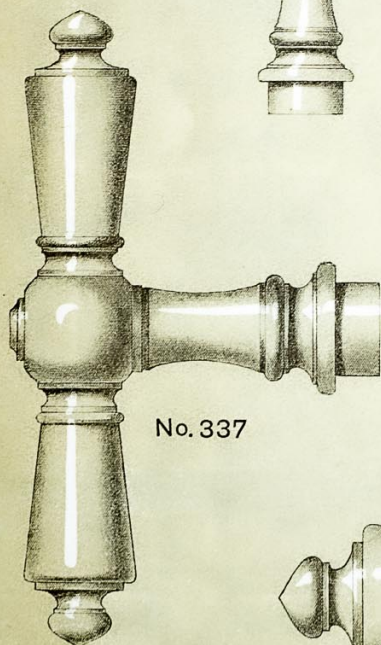

No. 337

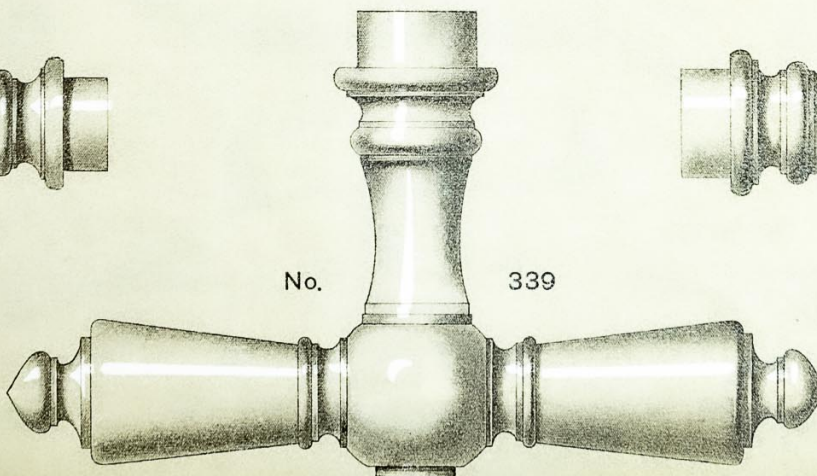

No. 339

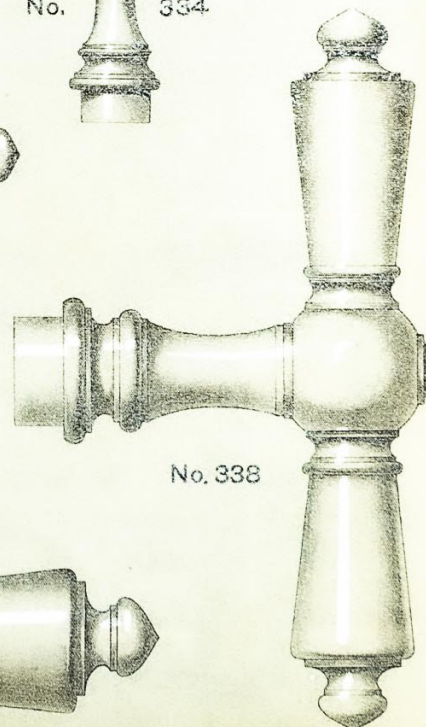

No. 338

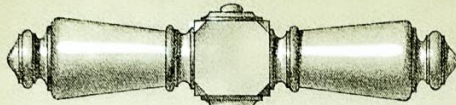

No. 345



No. 346

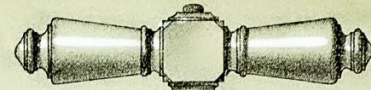

No. 344

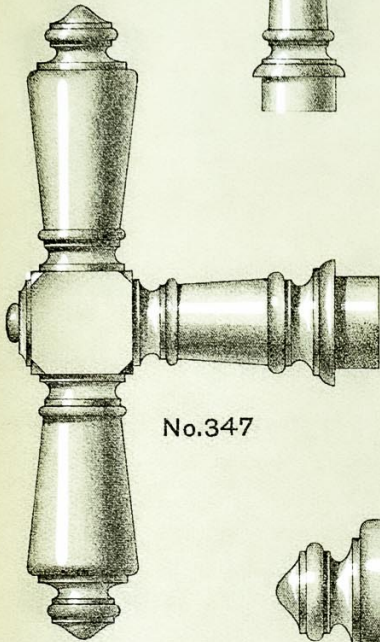
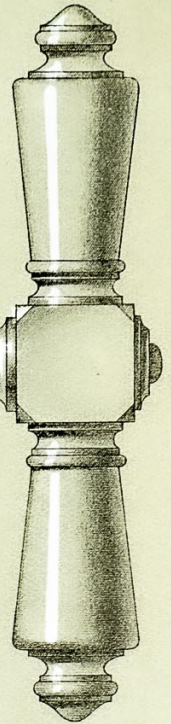
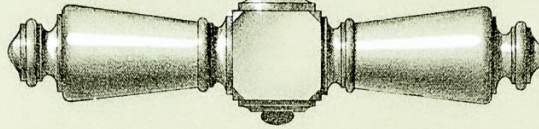

No. 347

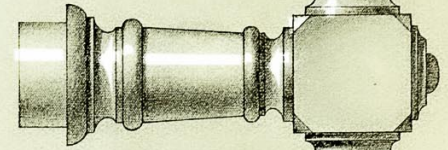

No. 348

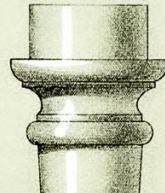

No. 349

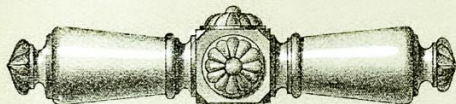
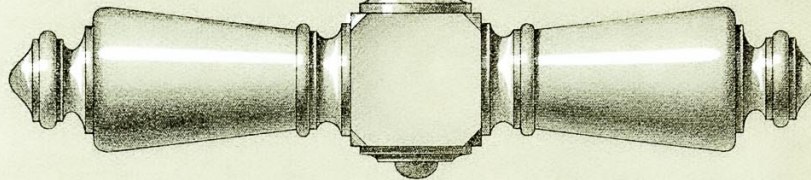

No. 355



No. 356

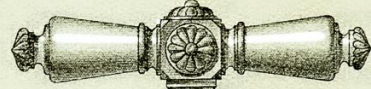

No. 354

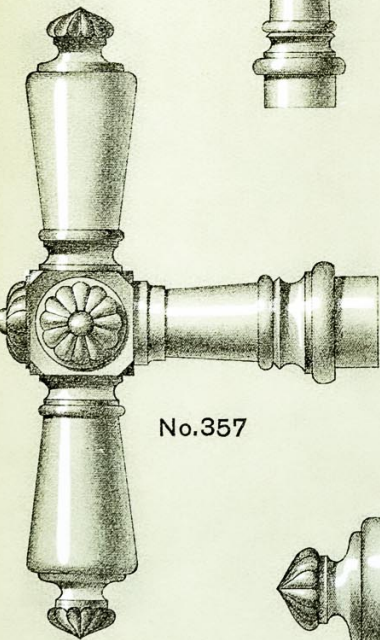
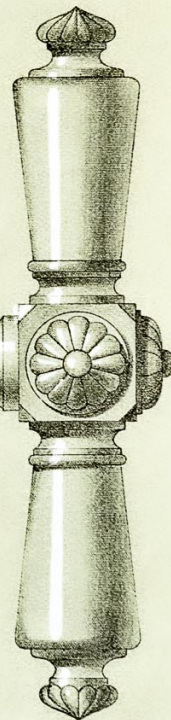

No. 357

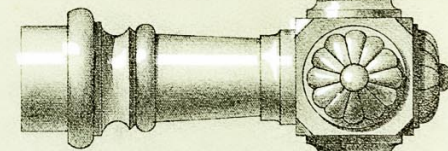

No. 358

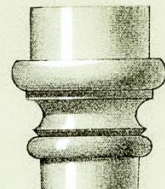

No. 359

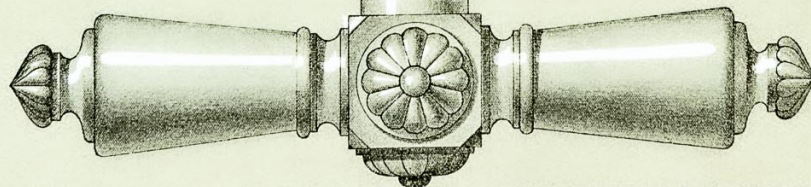

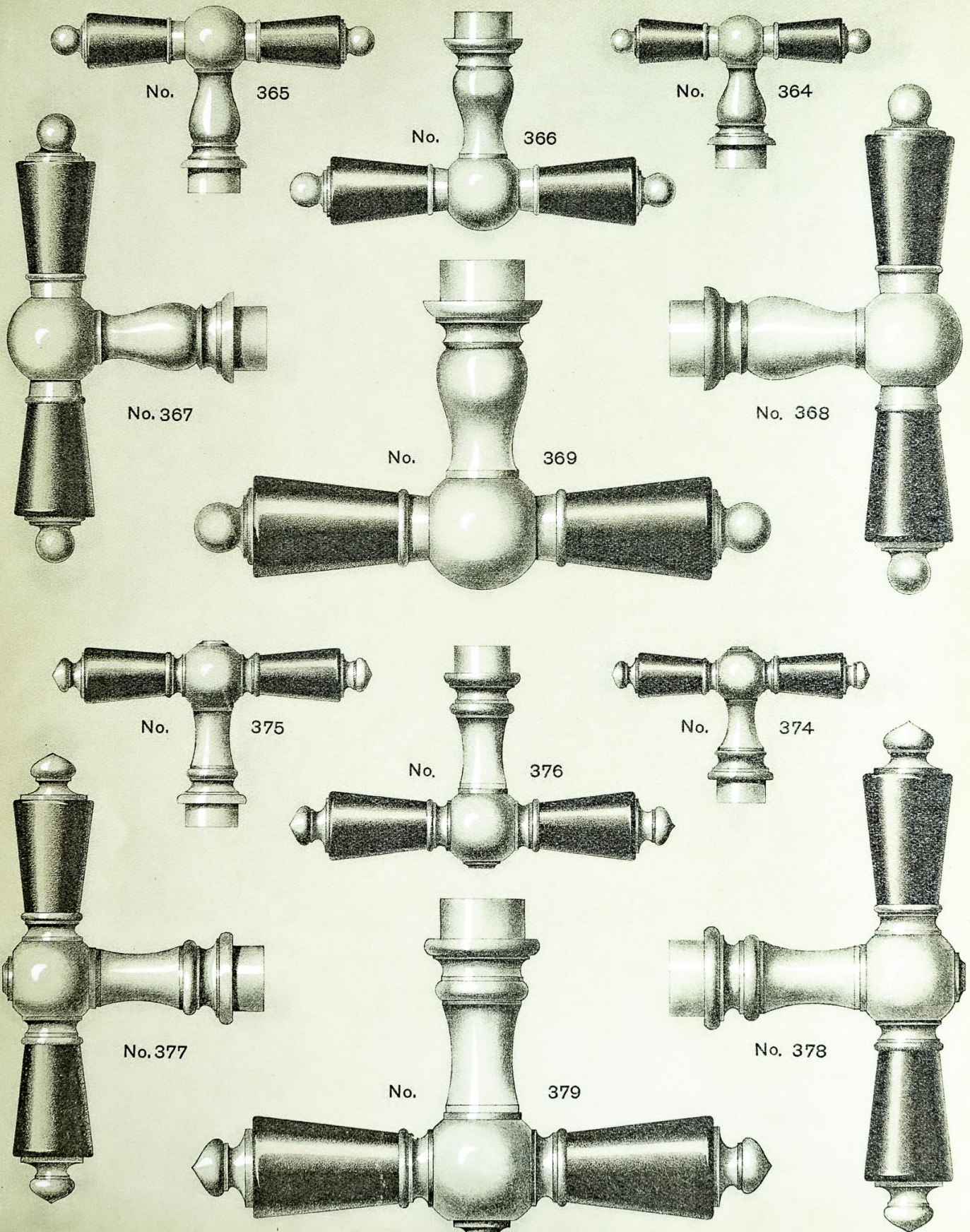

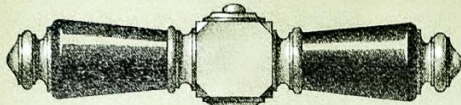

No. 385



No. 386

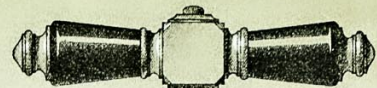

No. 384

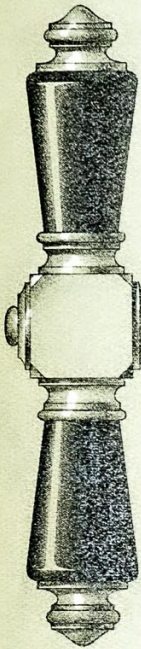

No. 387

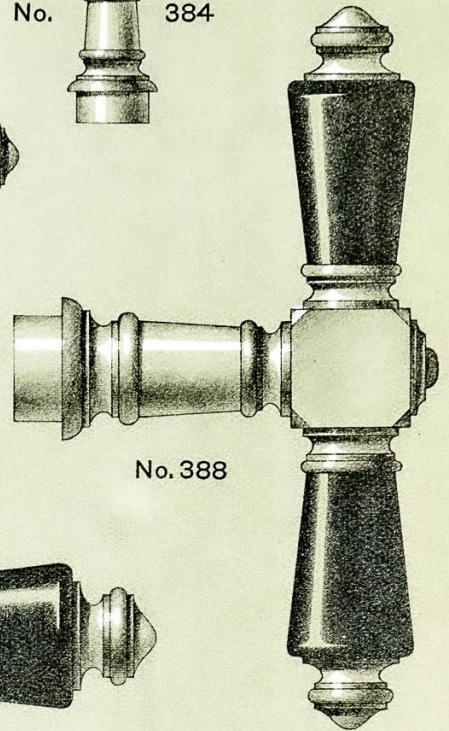
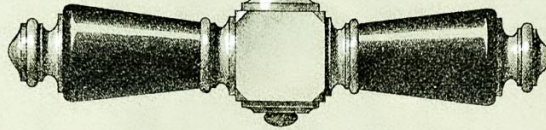

No. 388

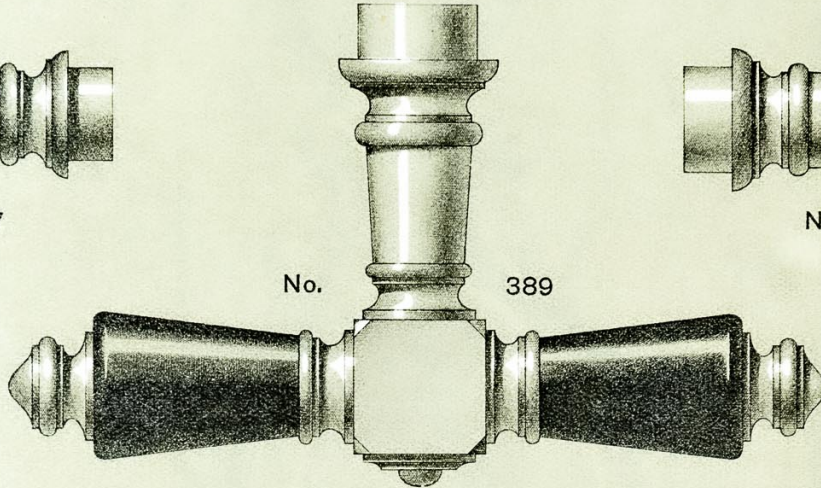

No. 389



No. 395



No. 396

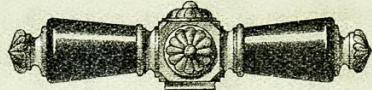

No. 394

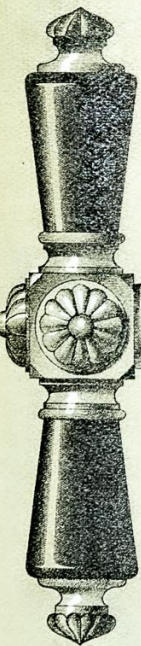

No. 397

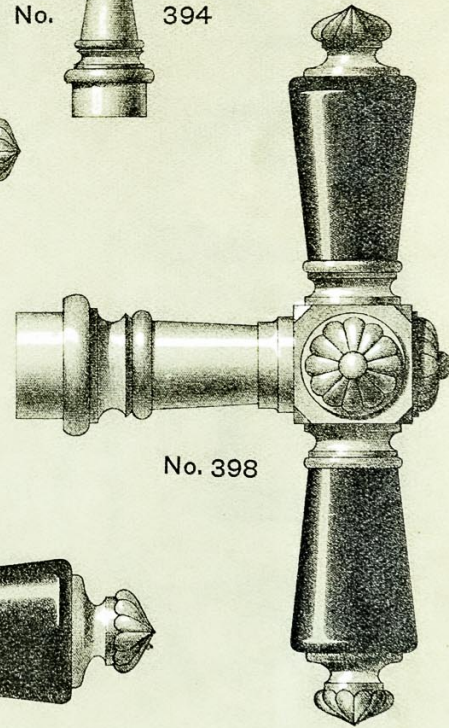
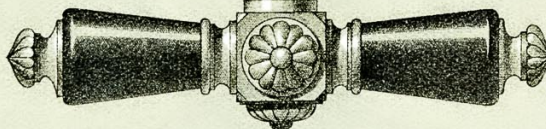

No. 398

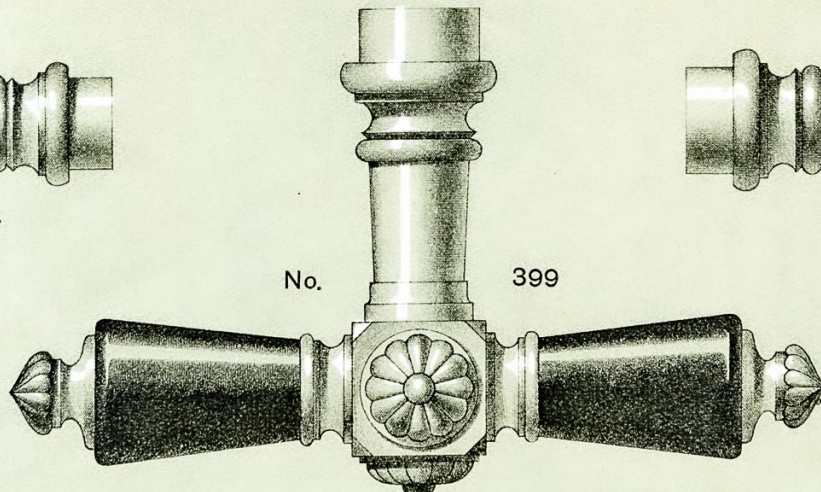

No. 399



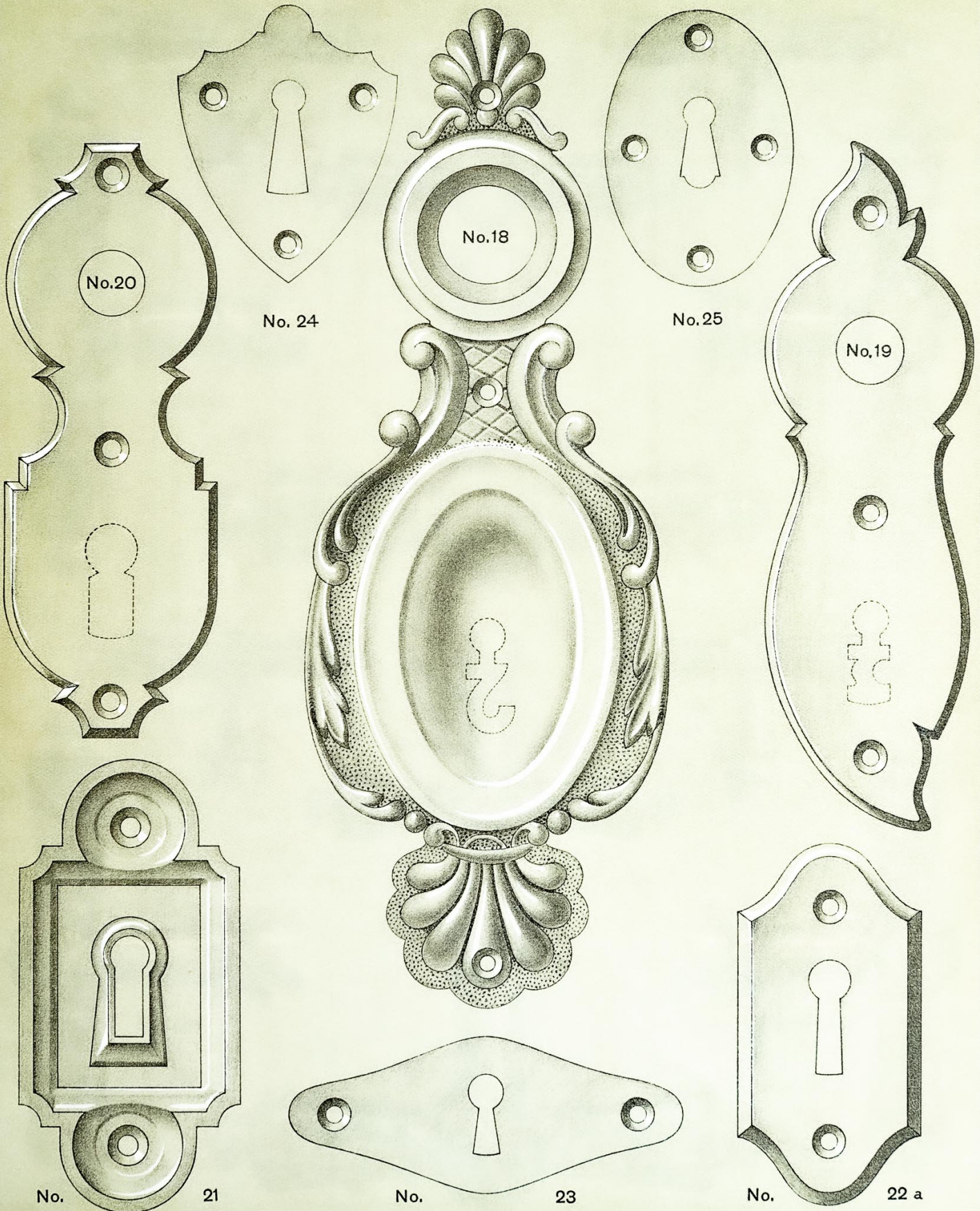

Flach - Plat

No. 3 (195 x 55)

No. 3 a (175 x 50)

Vertieft - A cuvette

No. 2 (195 x 55)

No. 2 a (175 x 55)

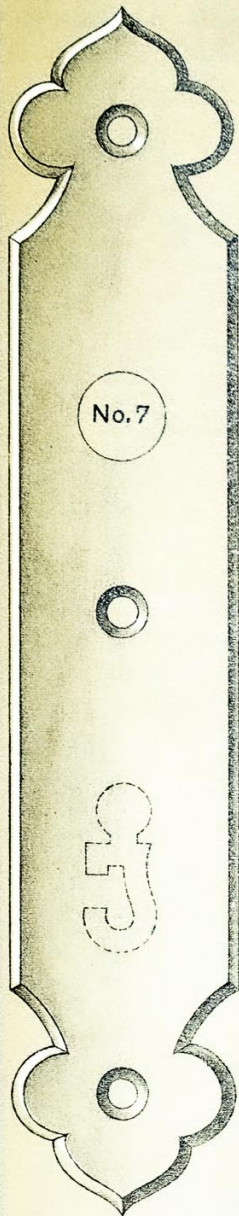

No. 7

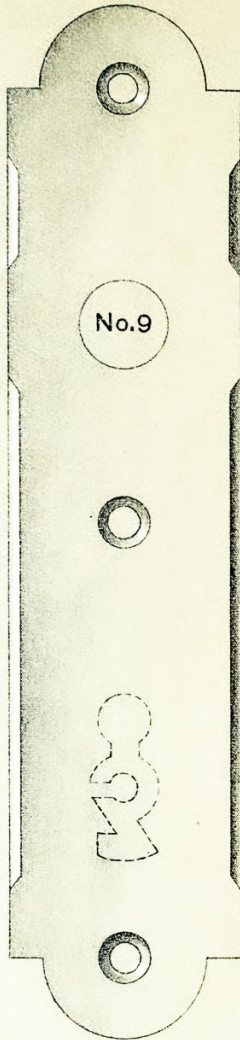

No. 9

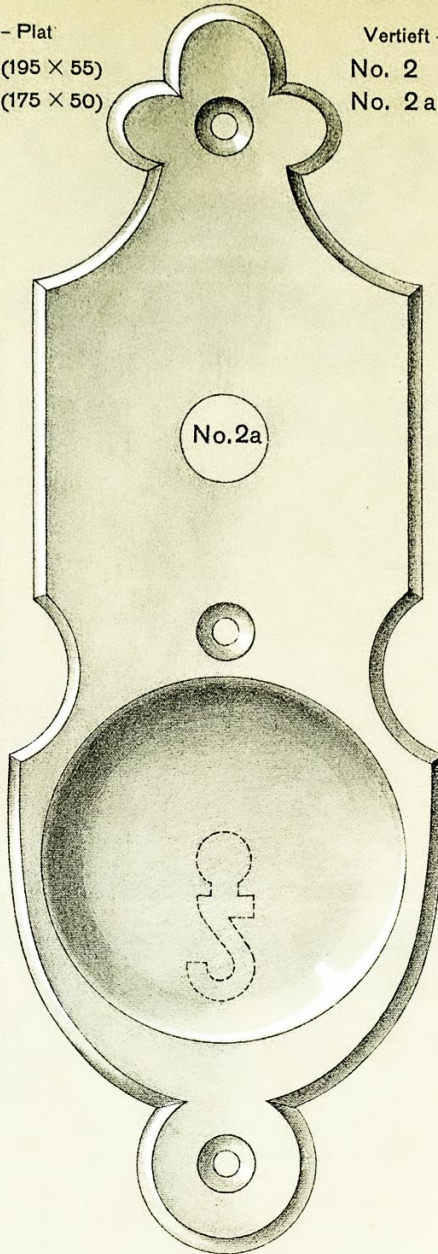

No. 2a

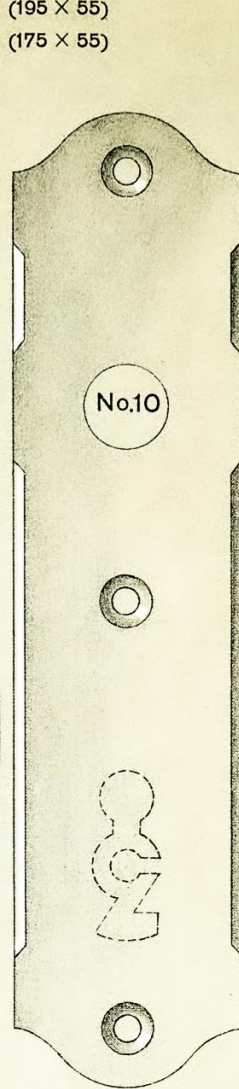

No. 10

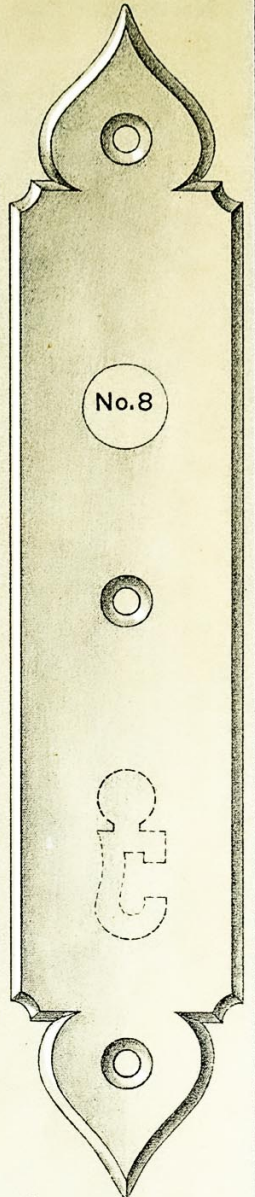

No. 8

No. 14

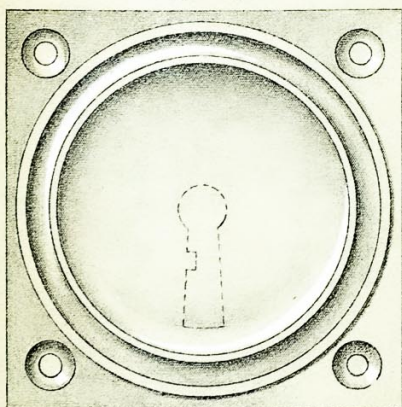

No. 1

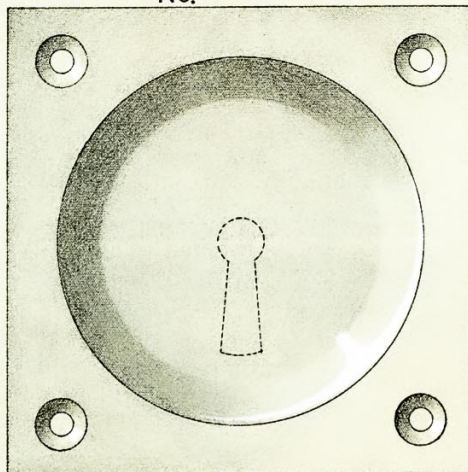

No. 15

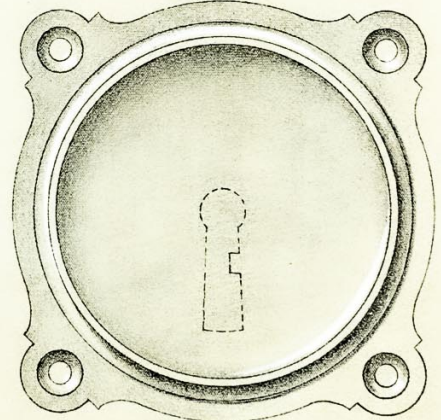

No. 4 (215 × 45)
No. 4 a (255 × 45)

Flach - Plat
No. 30 (260 × 50)
No. 30a (300 × 75)

Vertieft - A cuvette
No. 29 (260 × 50)
No. 29 a (300 × 75)

No. 5 (240 × 42)
No. 5 a (280 × 42)

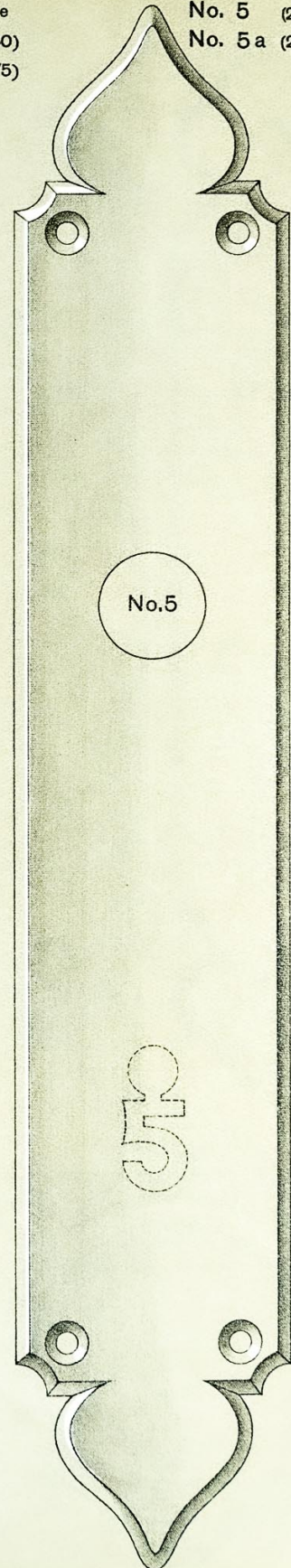
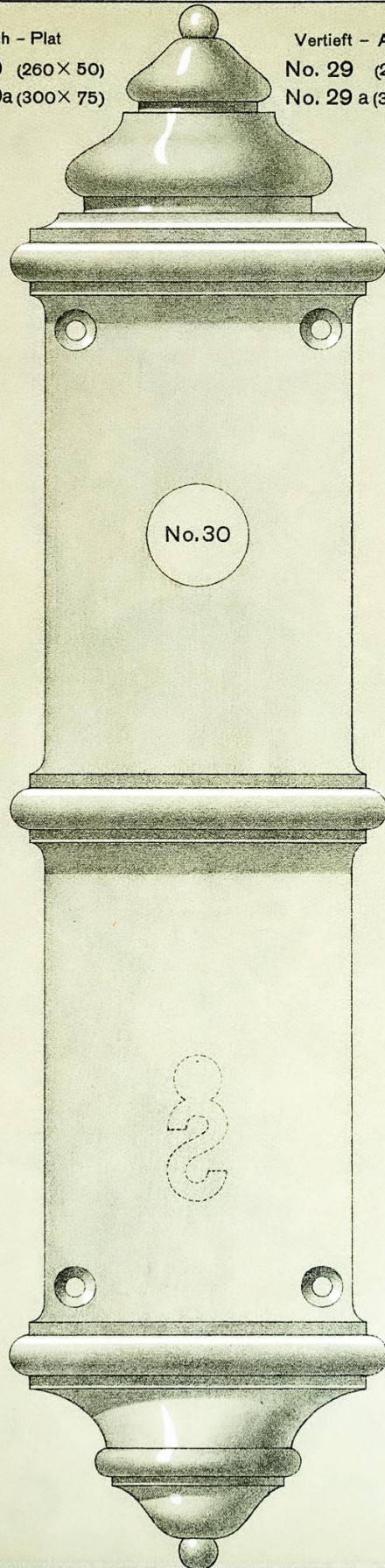
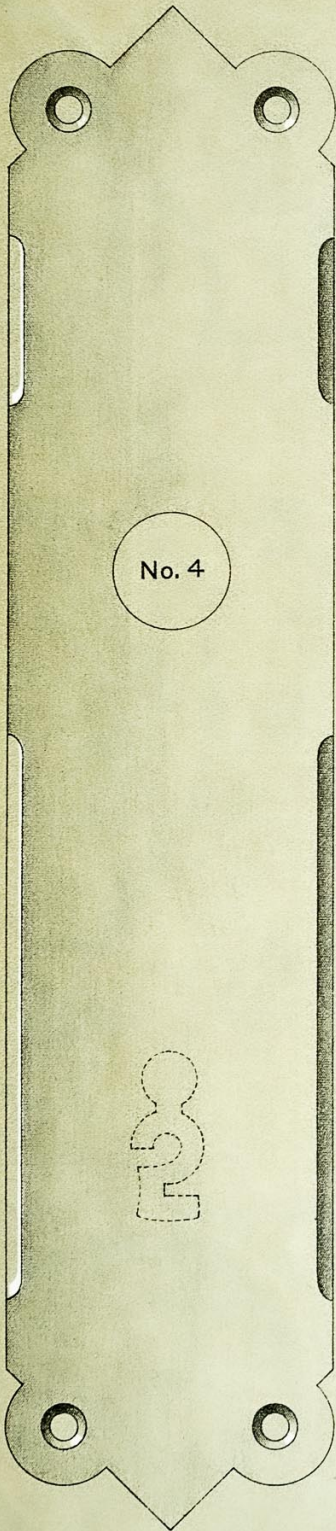

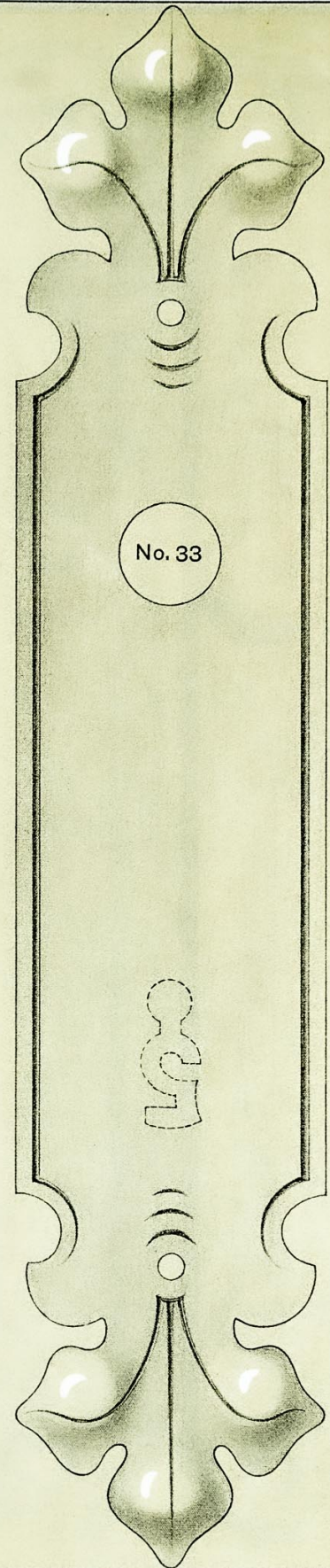
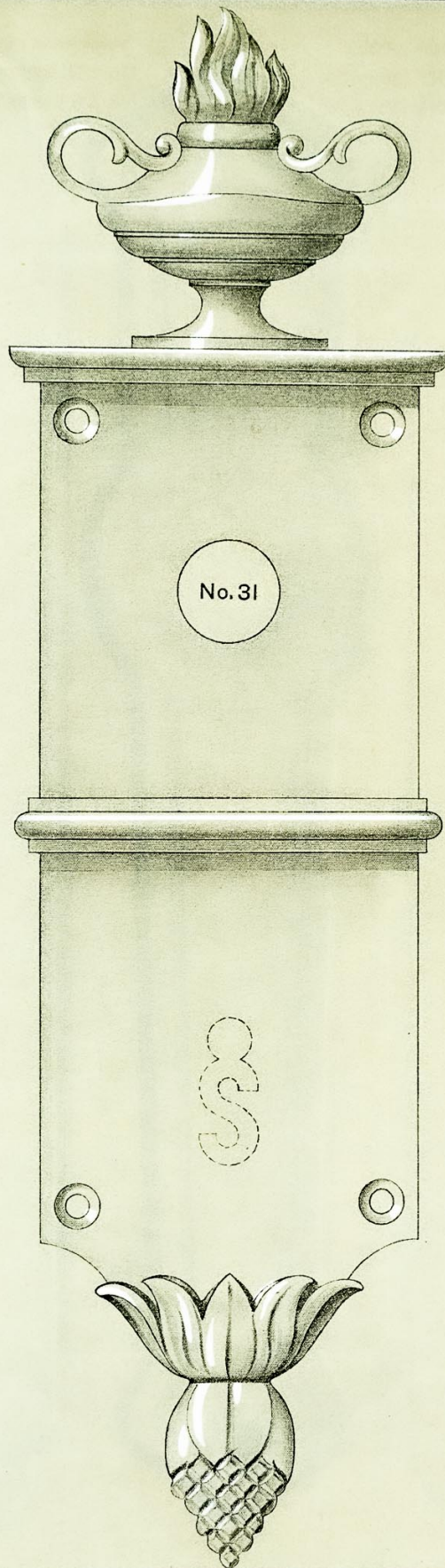
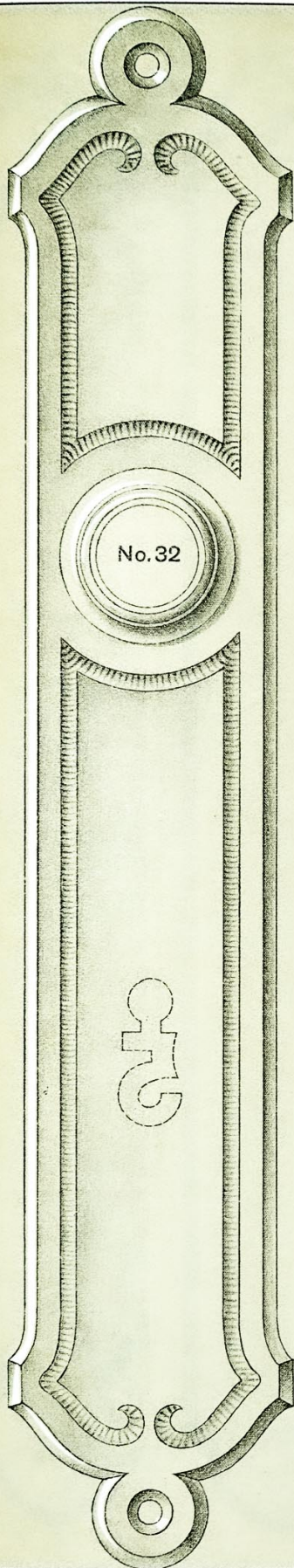

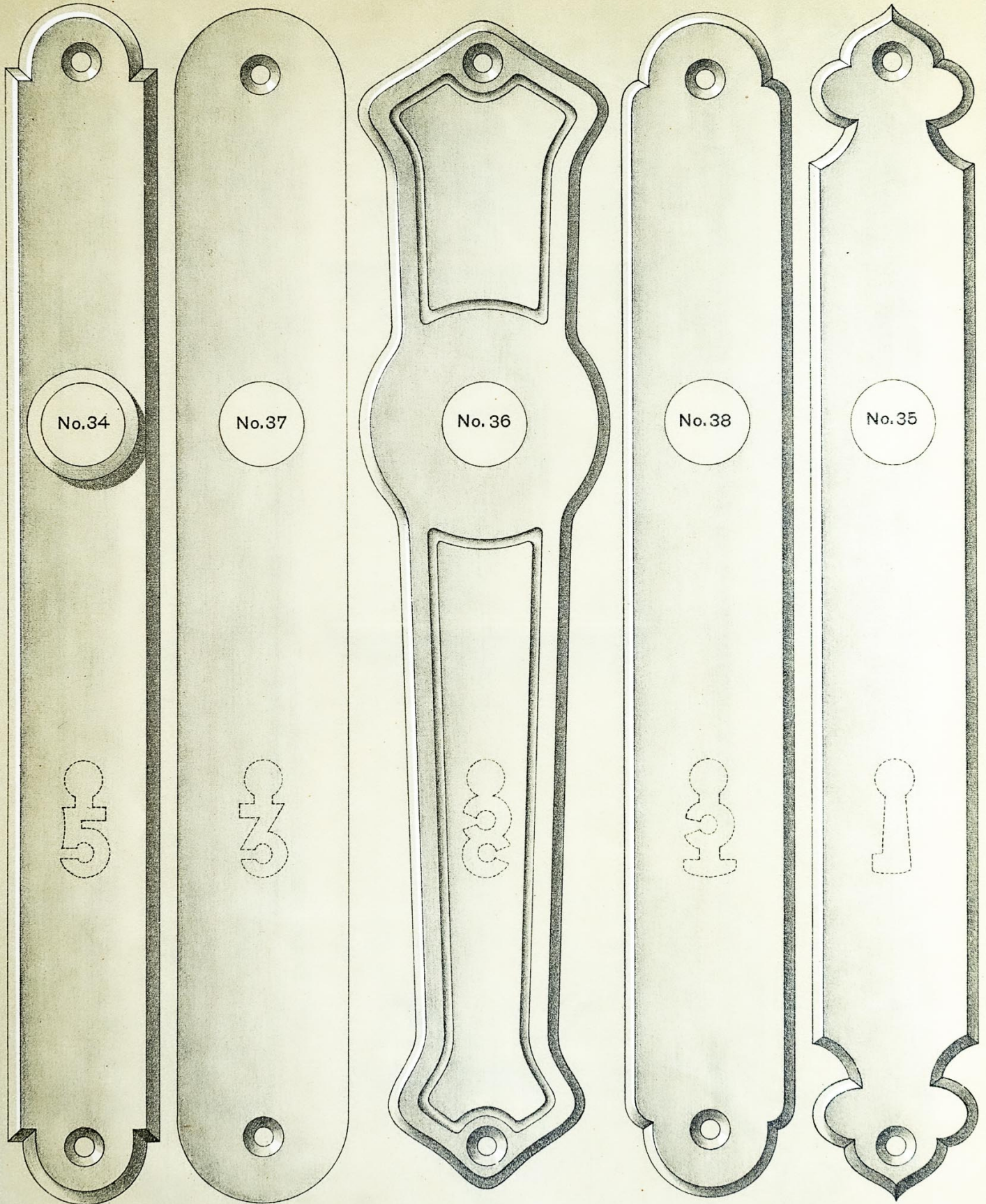

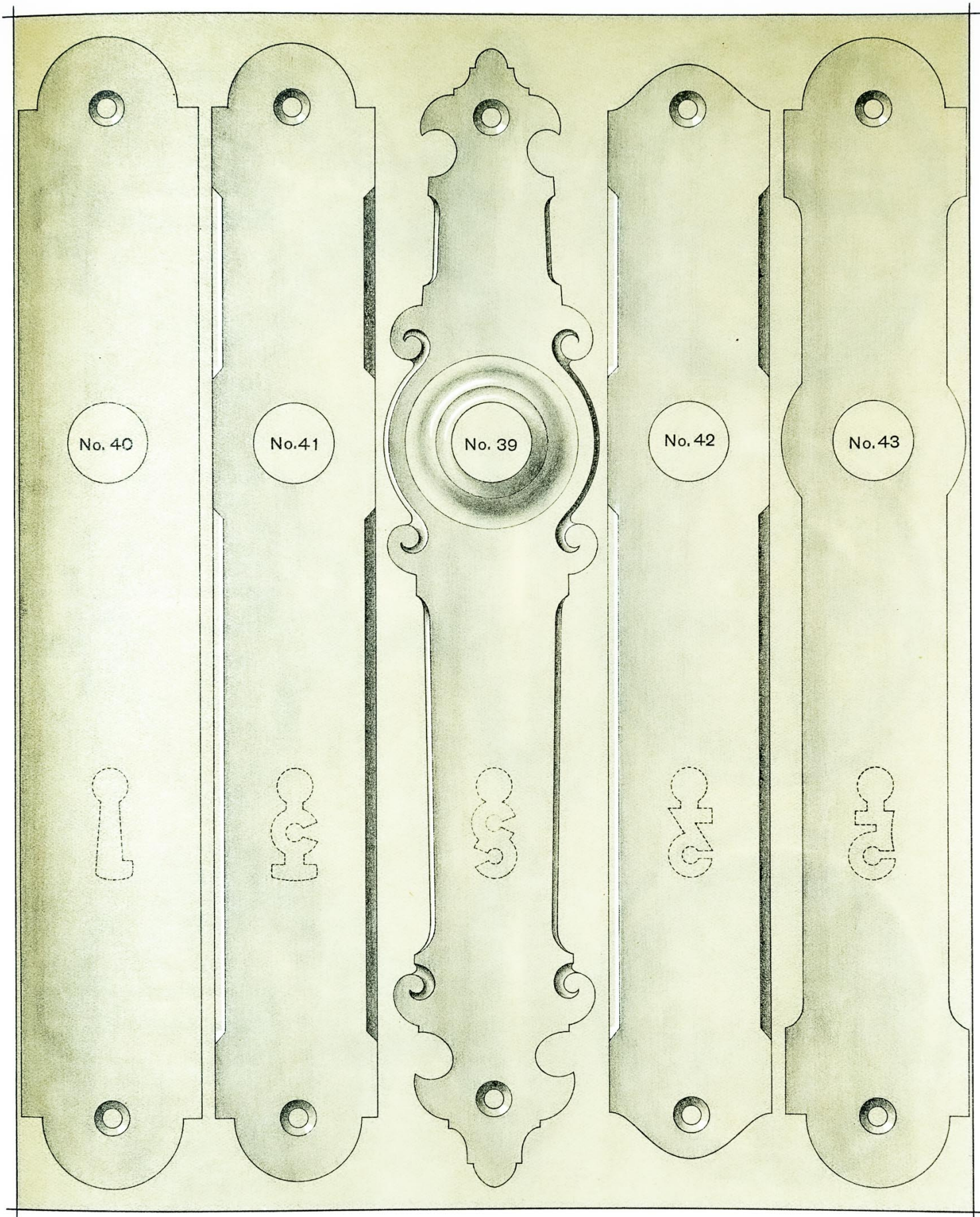

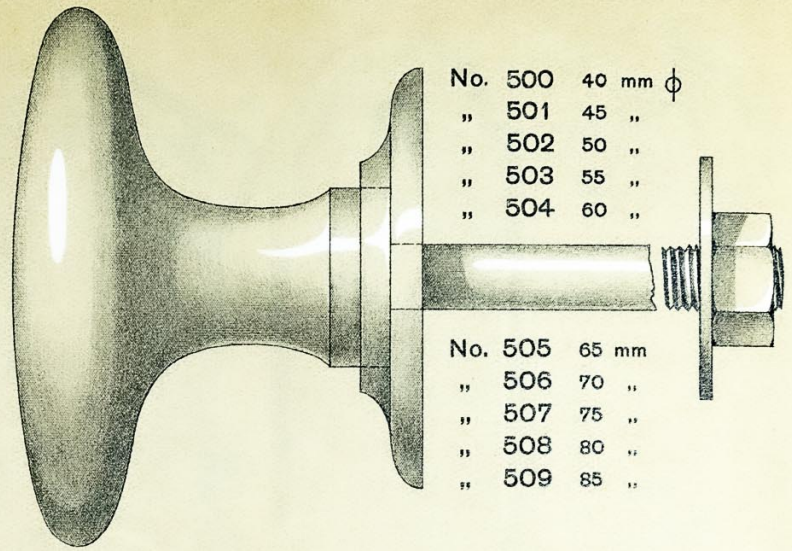
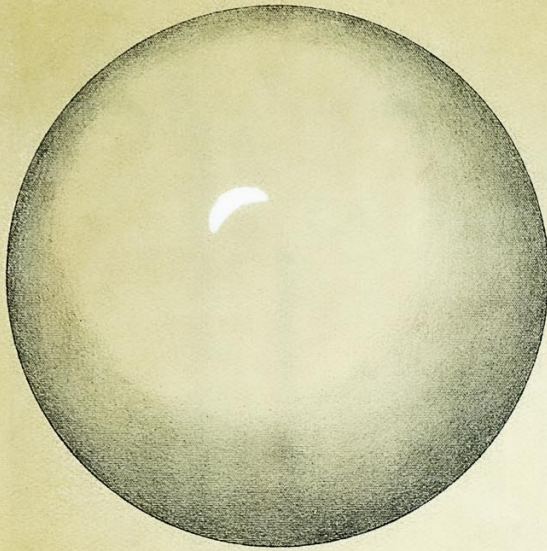

- No. 500 40 mm ϕ
- " 501 45 "
- " 502 50 "
- " 503 55 "
- " 504 60 "

- No. 505 65 mm
- " 506 70 "
- " 507 75 "
- " 508 80 "
- " 509 85 "

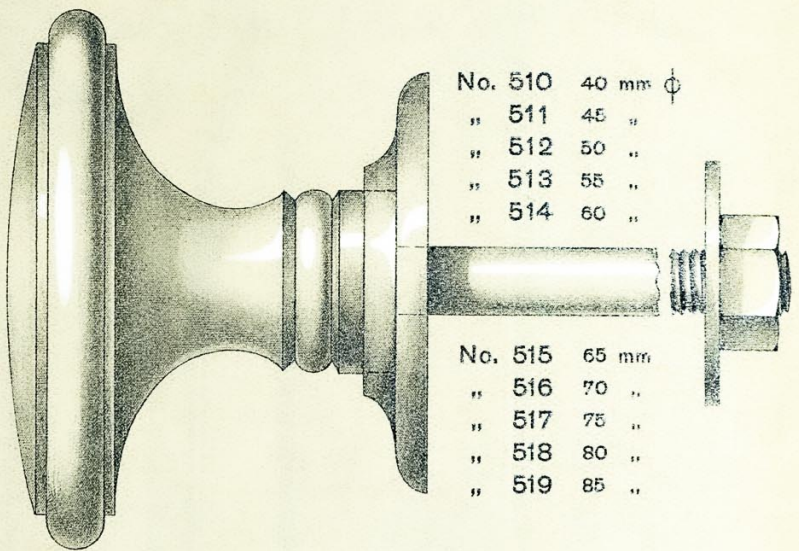
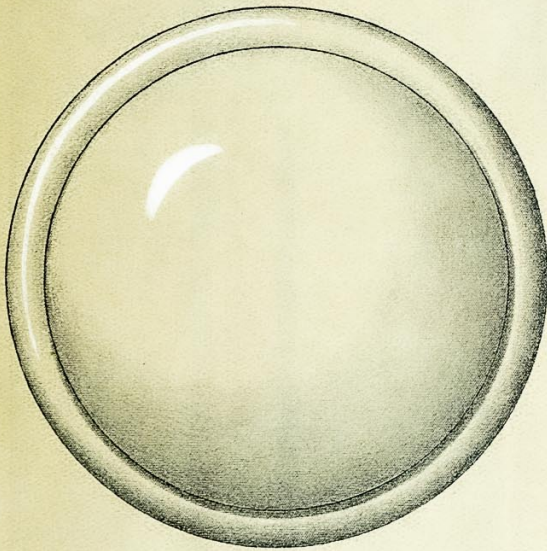

- No. 510 40 mm ϕ
- " 511 45 "
- " 512 50 "
- " 513 55 "
- " 514 60 "

- No. 515 65 mm
- " 516 70 "
- " 517 75 "
- " 518 80 "
- " 519 85 "

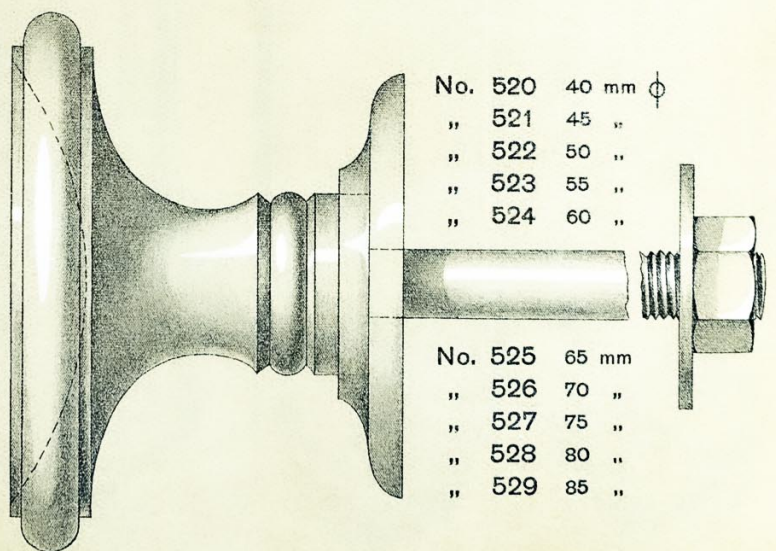
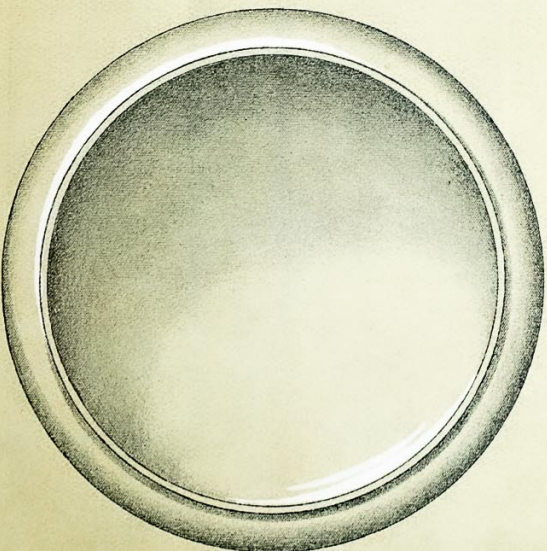

- No. 520 40 mm ϕ
- " 521 45 "
- " 522 50 "
- " 523 55 "
- " 524 60 "

- No. 525 65 mm
- " 526 70 "
- " 527 75 "
- " 528 80 "
- " 529 85 "



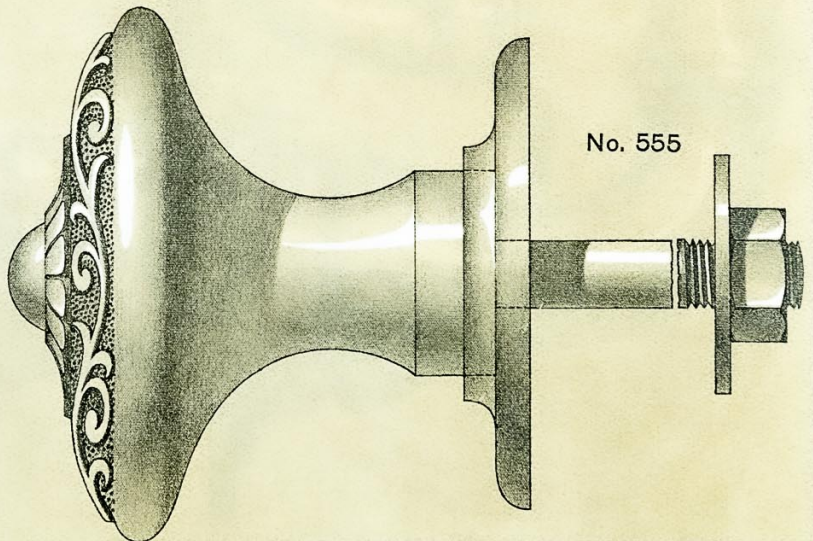
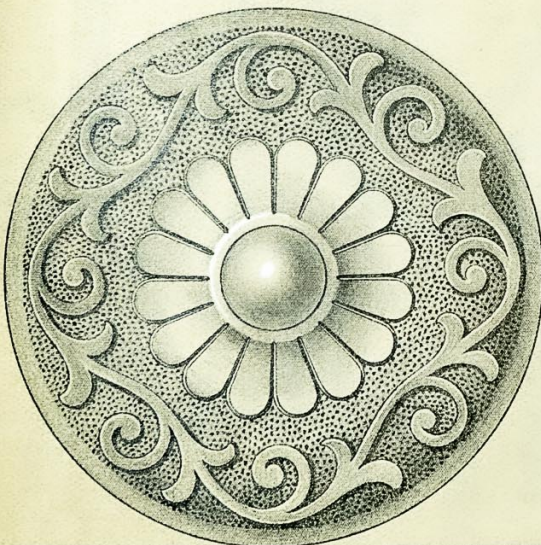
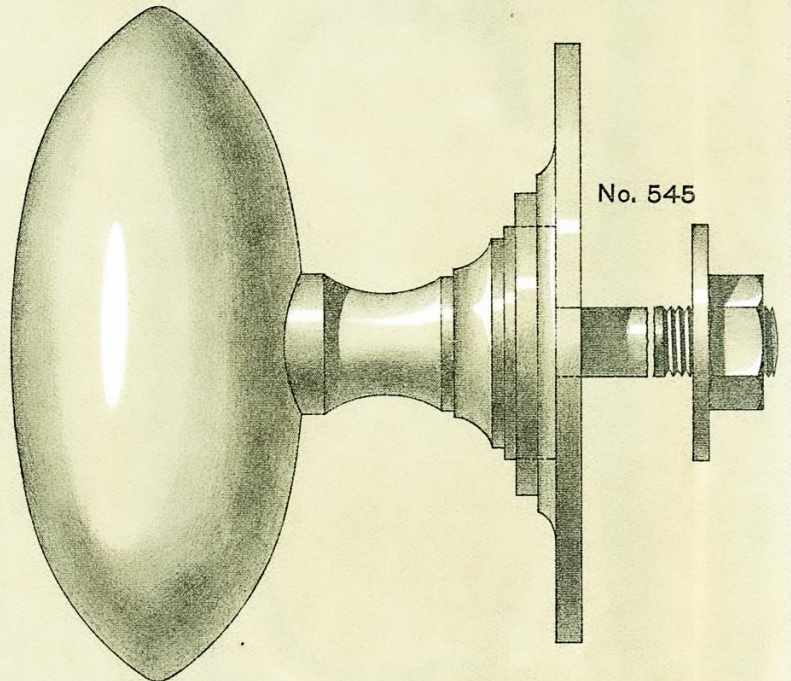
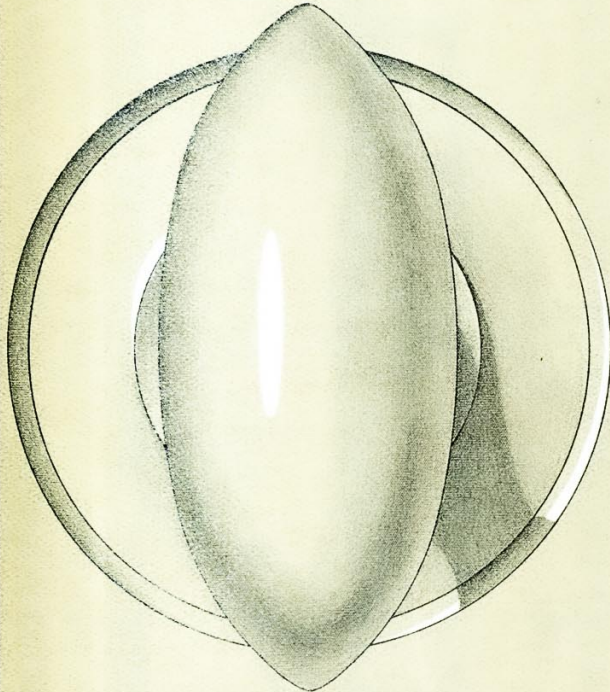
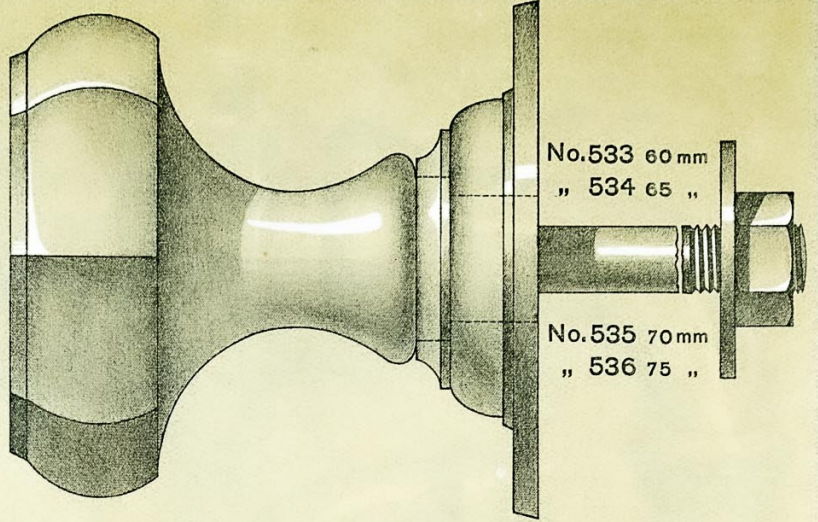
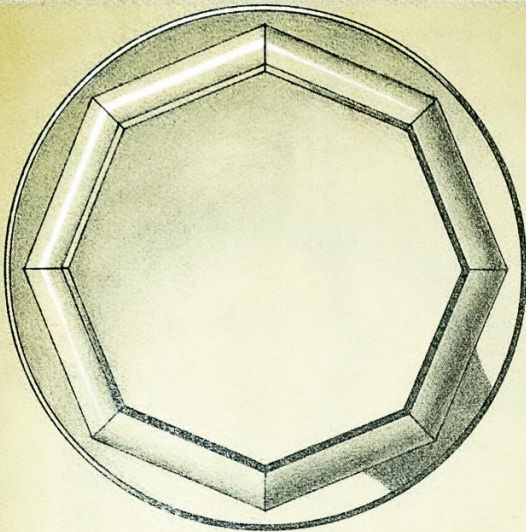

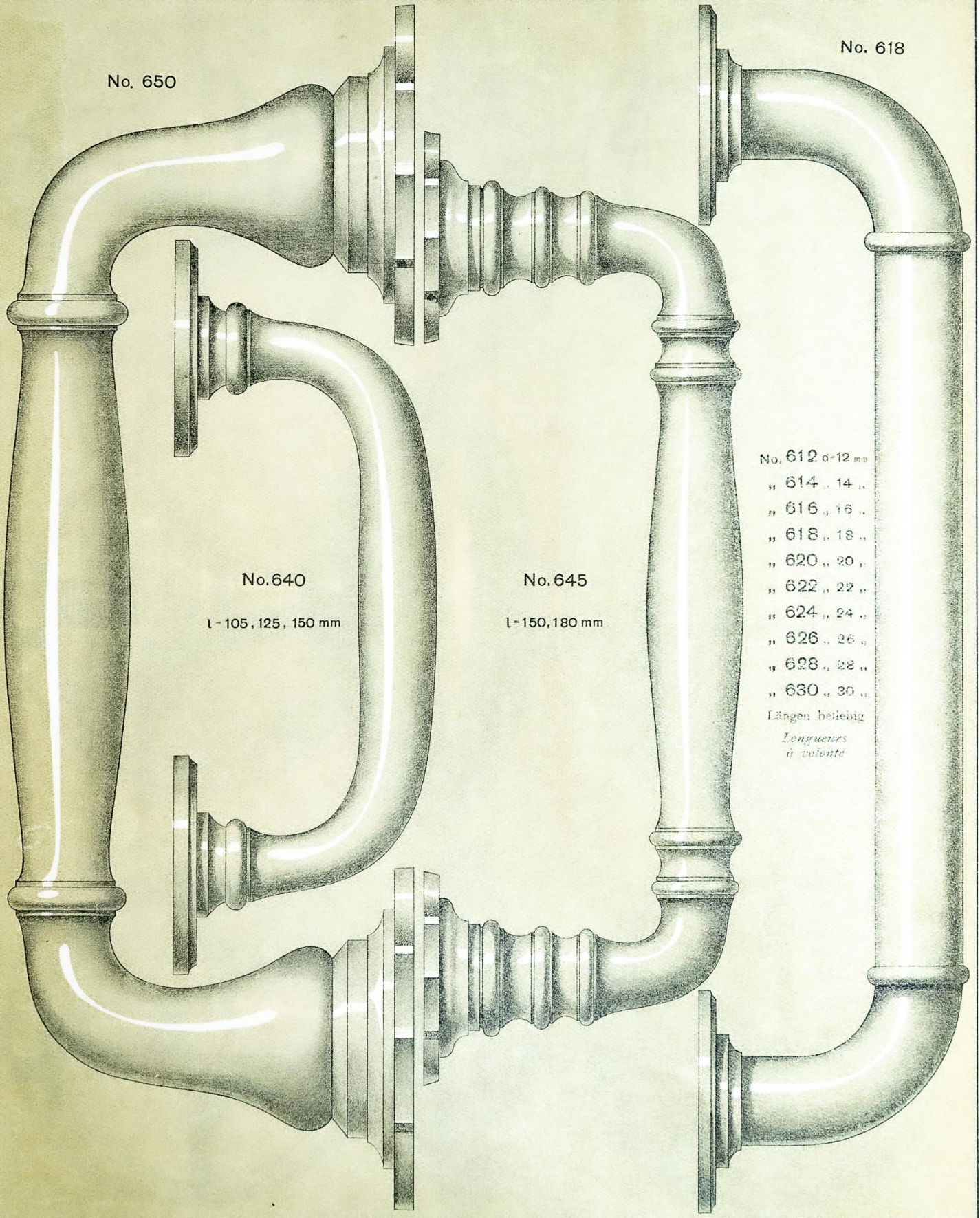

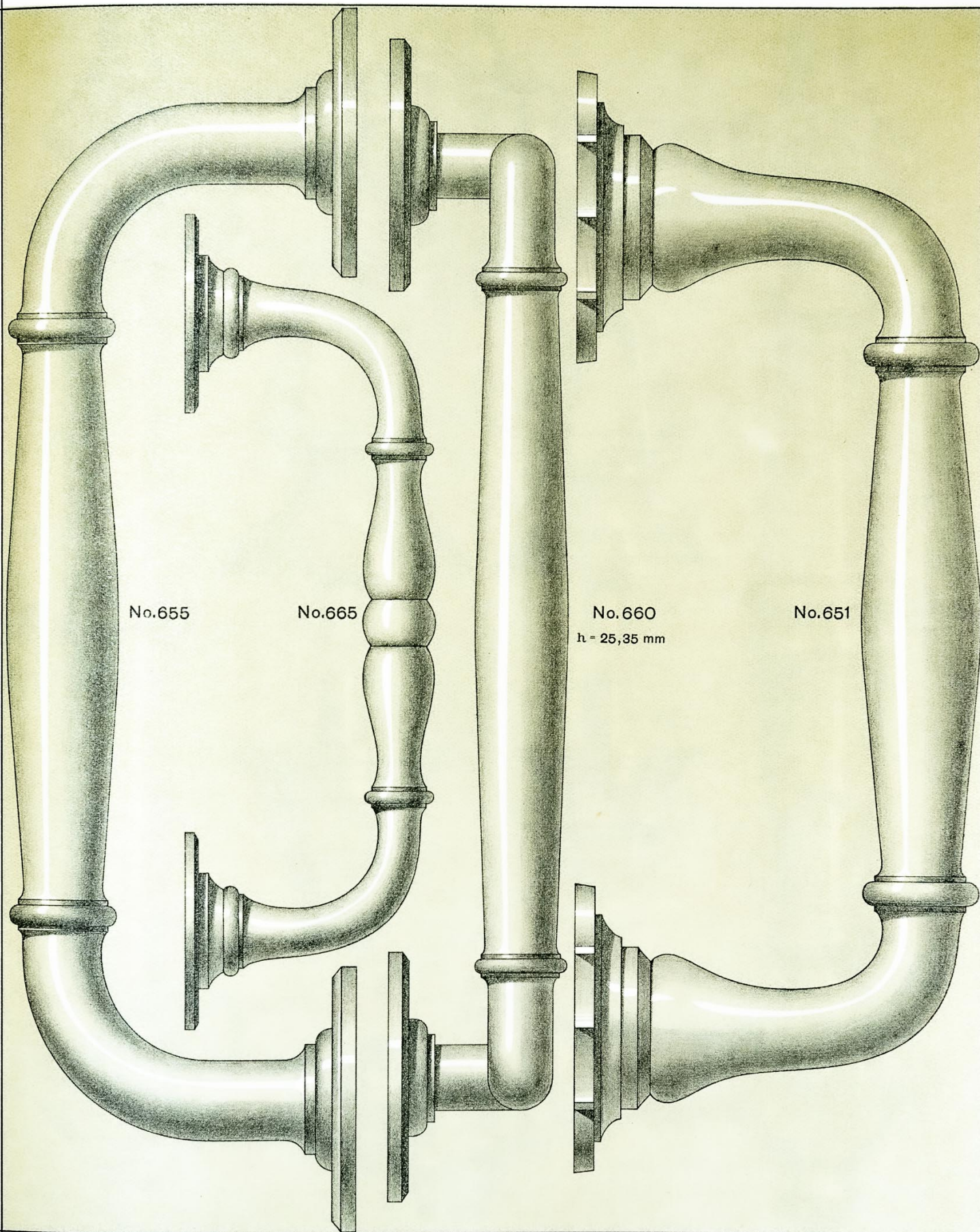

No.655

No.665

No.660
h = 25,35 mm

No.651



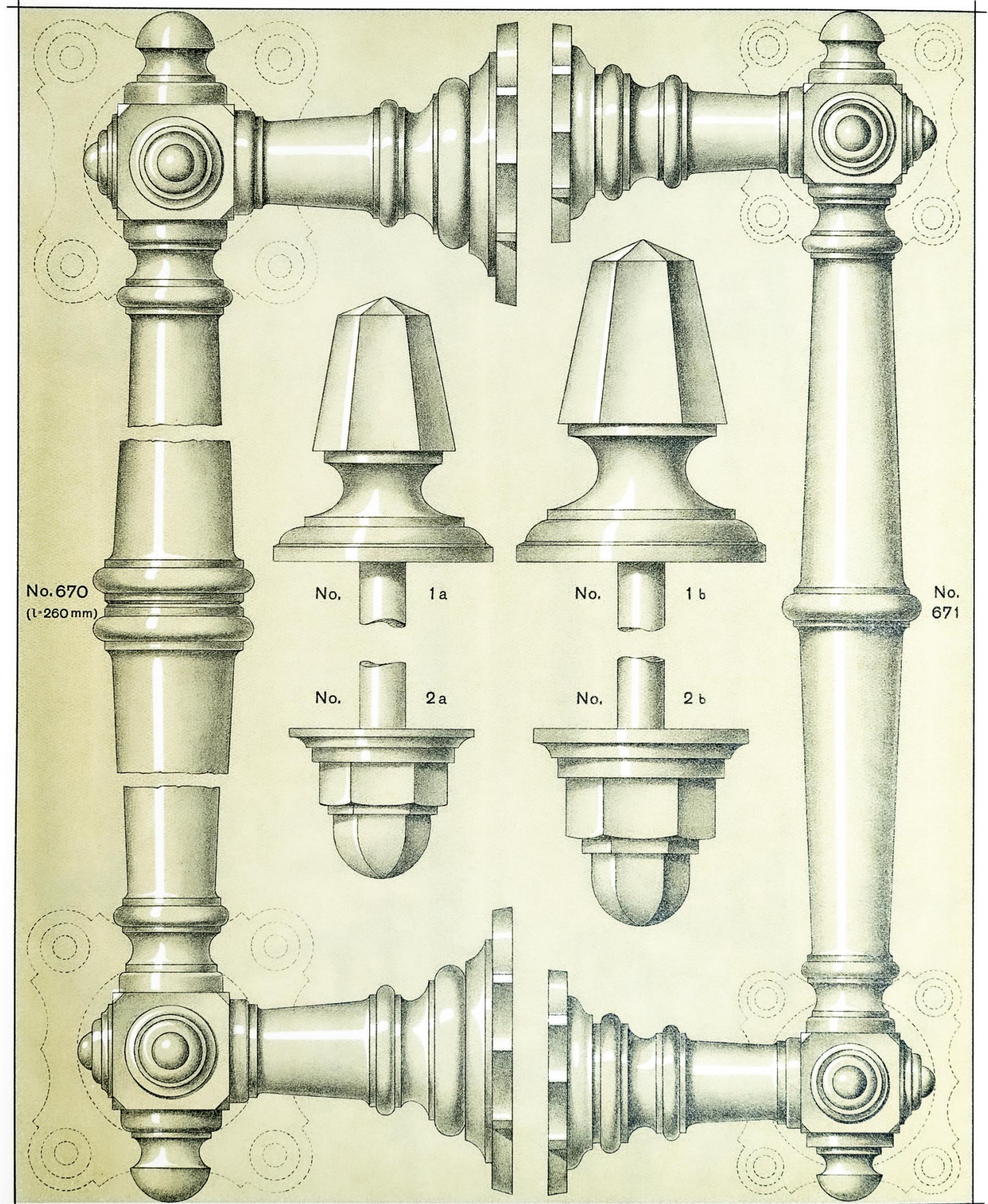

No. 670
(l=260mm)

No. 671

No. 1 a

No. 1 b

No. 2 a

No. 2 b



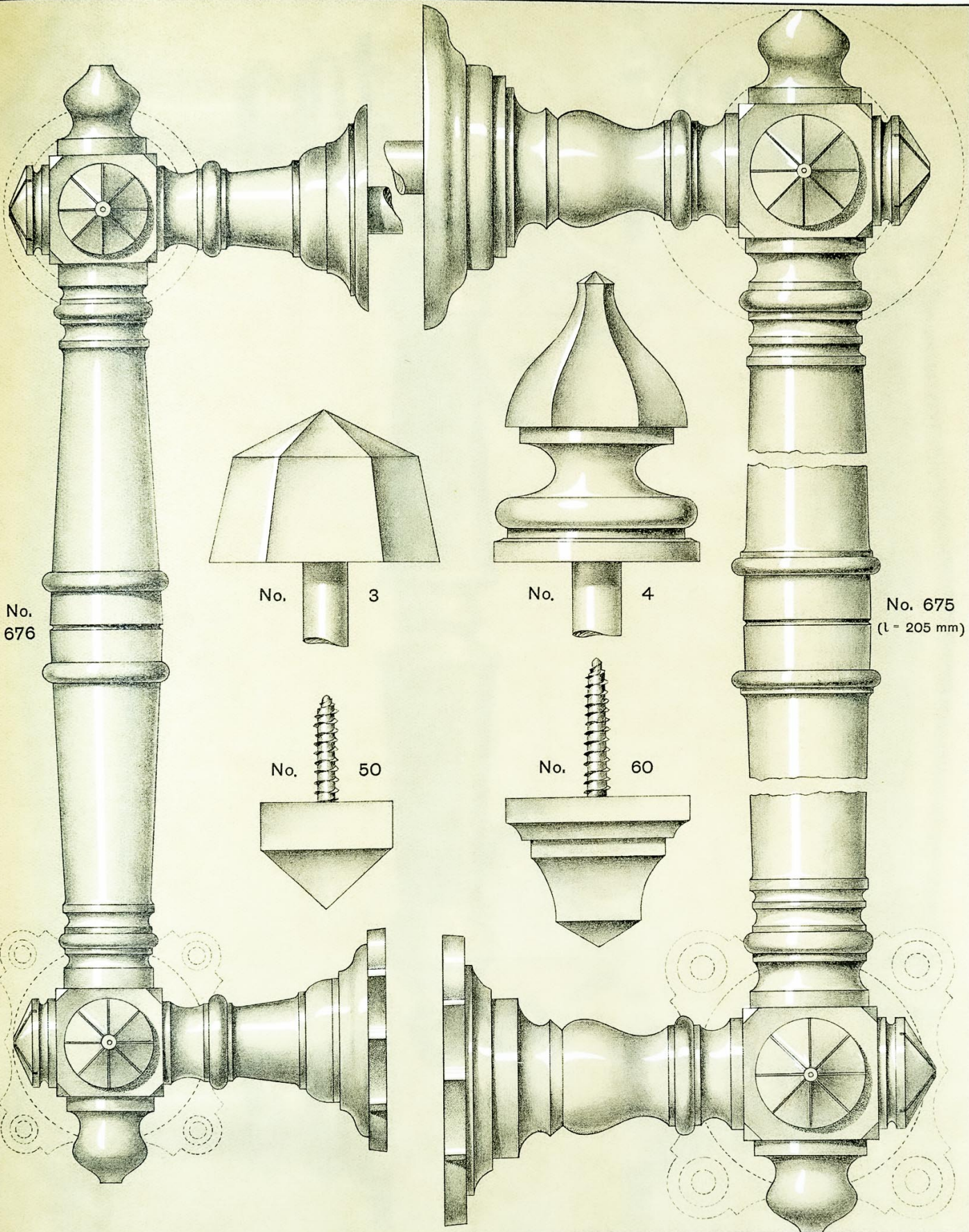

No. 676

No. 3

No. 4

No. 50

No. 60

No. 675
(L = 205 mm)



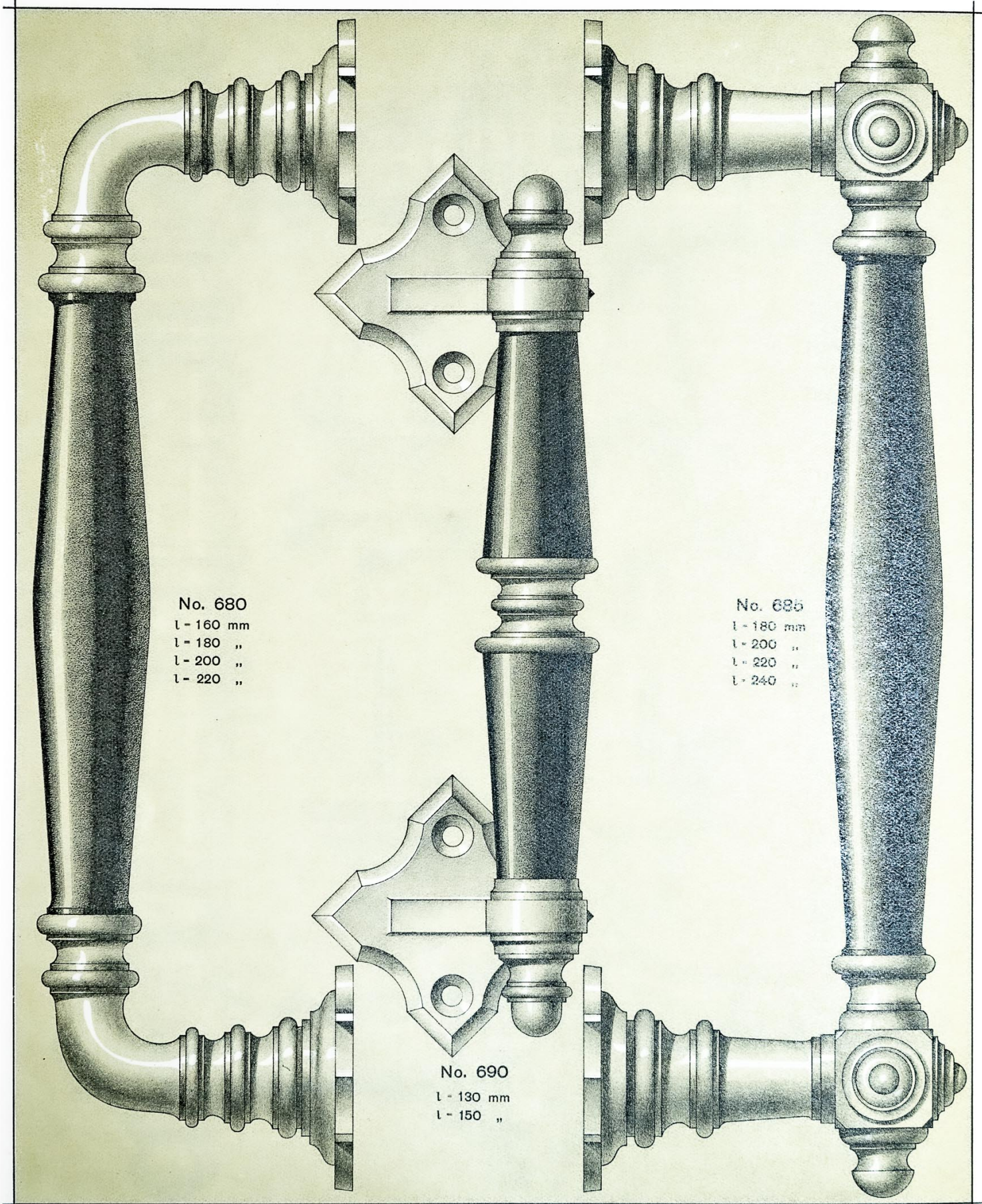

No. 680
l - 160 mm
l - 180 "
l - 200 "
l - 220 "

No. 685
l - 180 mm
l - 200 "
l - 220 "
l - 240 "

No. 690
l - 130 mm
l - 150 "



